



## **IPR722ES/LR7022E**

D/N 1080P HD Infrared IP Camera

## **IPR732ES**

D/N 3MP HD Infrared IP Camera

## **IPR722-IVS**

D/N 1080P HD IVS Infrared IP Camera

## **SR7022E**

D/N 1080P60 HD Infrared IP Camera

---

## **Quick Installation Guide**

**IMEGAPRO**

## CAUTION

- Do not drop or strike this equipment
- Do not install the equipment near any naked flames or heat sources
- Do not expose this unit to rain, moisture, smoke or dust environment
- Do not cover the opening of the cabinet with cloth and plastic or to install this unit in poor ventilated places. Allow 10cm between this unit and its surroundings
- Do not continue to operate the unit under abnormal conditions such as detection of smoke, strange smell or no display on screen while power is turned on
- Do not touch the power connection with wet hands
- Do not damage the power cord or leave it under pressure
- Do not operate this unit near magnet, speaker system, etc., to avoid unnecessary magnetic interference
- Connection cables should be grounded properly



## Product Overview

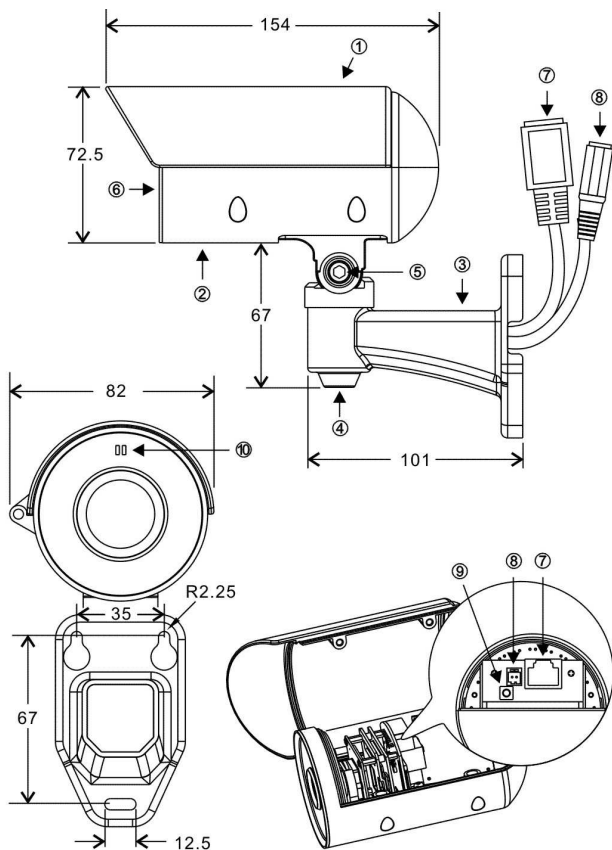

Unit: mm

- ① Top Cover
- ② Bottom Chassis
- ③ Bracket
- ④ Pan Adjustment Screw
- ⑤ Tilt Adjustment Screw
- ⑥ Lens
- ⑦ RJ-45 Network Port (Support PoE)
- ⑧ DC12V Power Input Jack (DC12V±10%)
- ⑨ Reset Key

To restore the server to factory default setting.

- ⑩ Network Indicator LEDs

Green(LINK): Network connection. This LED lit.

Orange(ACT): Data communications. This LED flashes.

## Installation

1. Take out the IP camera from the box. Connect the network cable to RJ-45 network port and connect power cable to DC power input jack of the IP camera (FIG.1). Then fix bracket to the wall (FIG.2).

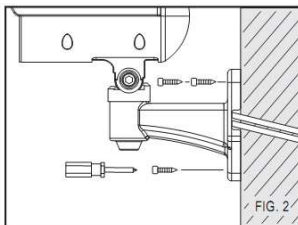
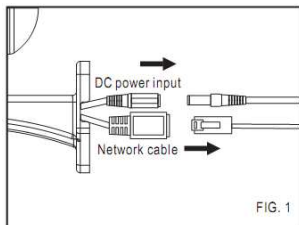

- Loosen the pan and tilt adjustment screws on the bracket to turn the camera body to the desired angle and then tighten the screws (FIG.3).

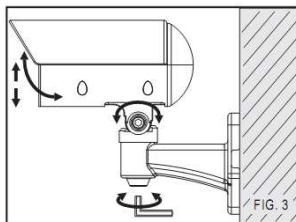

## System Architectures

For connecting HD IP cameras to the network, please follow one of the system architectures:

- Use DC12V power adapter and a network switch to connect to the network.

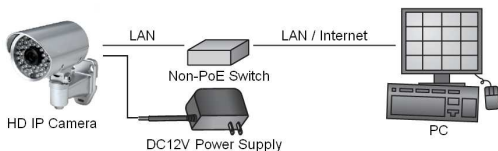

- Use a PoE network switch to connect to the network.

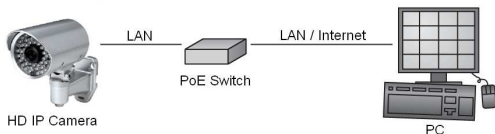

- (3). Use a PoE power injector and a network switch to connect to the network.

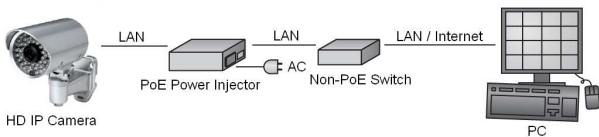

## Emergency Factory Default

To restore factory default settings by hardware, please follow these steps:

1. Hold "RESET Key" for 10 seconds, then release.
2. After about 40 seconds, the network LED light should turn off, and the back on again.
3. This camera has completed the factory default settings, and can then reboot.
4. Search for the IP device using the IPScan software.
5. Start the IP device via Internet browser.
6. Enter the default username "admin" and password "pass" to operate.

**NOTE:** For user convenience, restoring the factory default settings will revert to the default IP address 192.168.0.200.

## Before Accessing IP Cameras

Before accessing the IP camera, make sure that the camera's RJ-45 network, audio, and power cables are properly connected. To set the IP address, consult your network administrator for an available IP address. The default IP address for each IP camera is 192.168.0.200. Users can use the default IP address for verifying the camera's network connection.

## Software Requirements

Merit LILIN Universal ActiveX software components are required for web interface display of JPEG or H.264 Full HD video. When you login to the IP camera by Internet Explorer, the security warning dialog box will prompt the installation of the LILIN Universal ActiveX. Click **Install** to download it.



## Configuring IP Addresses by IPScan Software

To configure an IP address using the IP scan tool, you can copy the IPScan software from the installation CD, and paste to your computer. Alternatively, you can execute the IPScan software from the installation CD, or download the software from the Merit LILIN website ([www.meritlilin.com](http://www.meritlilin.com)). To change the settings of the IP address, subnet mask, gateway, or HTTP port, you can follow the steps below:

1. Run the IPScan software.
2. Click **Refresh**. All available Gateway devices should be listed in the device list.
3. Select your device from the list provided.
4. Change the IP address, subnet mask, gateway, or HTTP port for the IP camera.
5. Click **Apply** to submit the settings.
6. Click **Refresh** to verify the settings.

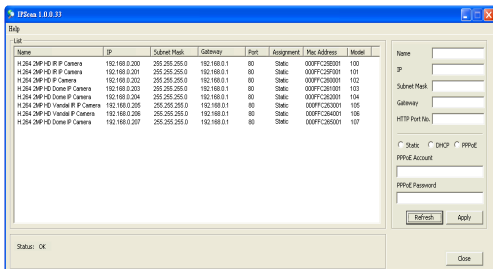

## Configuring IP Addresses via Web Interface

To change an IP address via web interface, type the default IP address (192.168.0.200) in the Internet browser and follow the steps below:

1. Login to the H.264 Full HD IP camera by the default username "admin" and default password "pass"
2. Click **Basic Mode** configuration hyperlink.
3. Click **Network->General** hyperlink.
4. Change the IP address, subnet mask, gateway, or HTTP port for the IP camera.
5. Click **Submit** to verify the settings.



## Internet Browser Settings & Application Required

Make sure your Internet browser allows the signed ActiveX plug-in to work on your computer. Set "Download Signed ActiveX plug-in controls" to "Prompt" and "Run ActiveX control and plug-in" to "Enable". You can set this option via Internet Explorer-> Tools-> Options-> Security Settings.



Once complete, you can access the IP camera's live video by entering the default IP address via your Internet browser. As the security warning dialog box appears, click **OK** to download the ActiveX directly from the IP camera.

## Login

There are two levels of user authentication, including admin and guest, that can access the IP camera. Administrator is authorized to reset basic mode settings and see live video, while the guest is allowed to see only live video.



The default usernames and passwords are as follows:

	Administrator
Username	admin
Password	pass

To logon the H.264 FULL HD IP camera, please type username and password in logon HTML page and click on Submit button to enter the system.

*Creativity, Progress, and Excellence*



**MERIT LILIN ENT. CO., LTD**

[www.meritlilin.com](http://www.meritlilin.com)

66-LR7022CSM