

HIKVISION

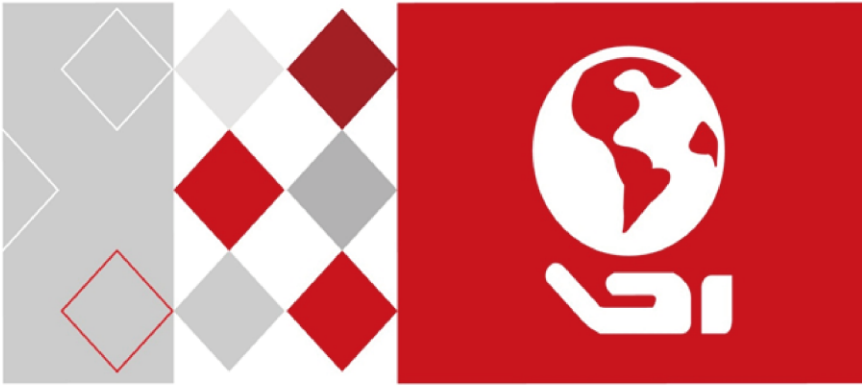

Wi-Fi Video Doorbell

User Manual

User Manual

©2018 Hangzhou Hikvision Digital Technology Co., Ltd.

About this Manual

This Manual is subject to domestic and international copyright protection. Hangzhou Hikvision Digital Technology Co., Ltd. ("Hikvision") reserves all rights to this manual. This manual cannot be reproduced, changed, translated, or distributed, partially or wholly, by any means, without the prior written permission of Hikvision.

Please use this user manual under the guidance of professionals.

Trademarks

HIKVISION and other Hikvision marks are the property of Hikvision and are registered trademarks or the subject of applications for the same by Hikvision and/or its affiliates. Other trademarks mentioned in this manual are the properties of their respective owners. No right of license is given to use such trademarks without express permission.

Disclaimer

TO THE MAXIMUM EXTENT PERMITTED BY APPLICABLE LAW, HIKVISION MAKES NO WARRANTIES, EXPRESS OR IMPLIED, INCLUDING WITHOUT LIMITATION THE IMPLIED WARRANTIES OF MERCHANTABILITY AND FITNESS FOR A PARTICULAR PURPOSE, REGARDING THIS MANUAL. HIKVISION DOES NOT WARRANT, GUARANTEE, OR MAKE ANY REPRESENTATIONS REGARDING THE USE OF THE MANUAL, OR THE CORRECTNESS, ACCURACY, OR RELIABILITY OF INFORMATION CONTAINED HEREIN. YOUR USE OF THIS MANUAL AND ANY RELIANCE ON THIS MANUAL SHALL BE WHOLLY AT YOUR OWN RISK AND RESPONSIBILITY.

TO THE MAXIMUM EXTENT PERMITTED BY APPLICABLE LAW, IN NO EVENT WILL HIKVISION, ITS DIRECTORS, OFFICERS, EMPLOYEES, OR AGENTS BE LIABLE TO YOU FOR ANY SPECIAL, CONSEQUENTIAL, INCIDENTAL, OR INDIRECT DAMAGES, INCLUDING, AMONG OTHERS, DAMAGES FOR LOSS OF BUSINESS PROFITS, BUSINESS INTERRUPTION, SECURITY BREACHES, OR LOSS OF DATA OR DOCUMENTATION, IN CONNECTION WITH THE USE OF OR RELIANCE ON THIS MANUAL, EVEN IF HIKVISION HAS BEEN ADVISED OF THE POSSIBILITY OF SUCH DAMAGES.

SOME JURISDICTIONS DO NOT ALLOW THE EXCLUSION OR LIMITATION OF LIABILITY OR CERTAIN DAMAGES, SO SOME OR ALL OF THE ABOVE EXCLUSIONS OR LIMITATIONS MAY NOT APPLY TO YOU.

Regulatory Information

FCC Information

Please take attention that changes or modification not expressly approved by the party responsible for compliance could void the user’s authority to operate the equipment.

FCC compliance: This equipment has been tested and found to comply with the limits for a Class A digital device, pursuant to part 15 of the FCC Rules. These limits are designed to provide reasonable protection against harmful interference when the equipment is operated in a commercial environment. This equipment generates, uses, and can radiate radio frequency energy and, if not installed and used in accordance with the instruction manual, may cause harmful interference to radio communications. Operation of this equipment in a residential area is likely to cause harmful interference in which case the user will be required to correct the interference at his own expense.

FCC Conditions

This device complies with part 15 of the FCC Rules. Operation is subject to the following two conditions:

1. This device may not cause harmful interference.
2. This device must accept any interference received, including interference that may cause undesired operation.

EU Conformity Statement



This product and - if applicable - the supplied accessories too are marked with "CE" and comply therefore with the applicable harmonized European standards listed under the EMC Directive 2014/30/EU, the RoHS Directive 2011/65/EU.



2012/19/EU (WEEE directive): Products marked with this symbol cannot be disposed of as unsorted municipal waste in the European Union. For proper recycling, return this product to your local supplier upon the purchase of equivalent new equipment, or dispose of it at designated collection points. For more information see: www.recyclethis.info



2006/66/EC (battery directive): This product contains a battery that cannot be disposed of as unsorted municipal waste in the European Union. See the product documentation for specific battery information. The battery is marked with this symbol, which may include lettering to indicate cadmium (Cd), lead (Pb), or mercury (Hg). For proper recycling, return the battery to your supplier or to a designated collection point. For more information see: www.recyclethis.info

Industry Canada ICES-003 Compliance

This device meets the CAN ICES-3 (A)/NMB-3(A) standards requirements.

This device complies with Industry Canada licence-exempt RSS standard(s). Operation is subject to the following two conditions:

- (1) this device may not cause interference, and

(2) this device must accept any interference, including interference that may cause undesired operation of the device.

Le présent appareil est conforme aux CNR d'Industrie Canada applicables aux appareils radioexempts de licence. L'exploitation est autorisée aux deux conditions suivantes :

(1) l'appareil ne doit pas produire de brouillage, et

(2) l'utilisateur de l'appareil doit accepter tout brouillage radioélectrique subi, même si le brouillage est susceptible d'en compromettre le fonctionnement.

Under Industry Canada regulations, this radio transmitter may only operate using an antenna of a type and maximum (or lesser) gain approved for the transmitter by Industry Canada. To reduce potential radio interference to other users, the antenna type and its gain should be so chosen that the equivalent isotropically radiated power (e.i.r.p.) is not more than that necessary for successful communication.

Conformément à la réglementation d'Industrie Canada, le présent émetteur radio peut fonctionner avec une antenne d'un type et d'un gain maximal (ou inférieur) approuvé pour l'émetteur par Industrie Canada. Dans le but de réduire les risques de brouillage radioélectrique à l'intention des autres utilisateurs, il faut choisir le type d'antenne et son gain de sorte que la puissance isotrope rayonnée équivalente (p.i.r.e.) ne dépasse pas l'intensité nécessaire à l'établissement d'une communication satisfaisante.

This equipment should be installed and operated with a minimum distance 20cm between the radiator and your body.



Cet équipement doit être installé et utilisé à une distance minimale de 20 cm entre le radiateur et votre corps.

Available Models

This manual is applicable to the Wi-Fi Video Doorbell: DS-KB6003-WIP, DS-KB6403-WIP.

Symbol Conventions

The symbols that may be found in this document are defined as follows.

Symbol	Description
 DANGER	Indicates a hazardous situation which, if not avoided, will or could result in death or serious injury.
 WARNING	Indicates a potentially hazardous situation which, if not avoided, could result in equipment damage, data loss, performance degradation, or unexpected results.
 NOTE	Provides additional information to emphasize or supplement important points of the main text.

Safety Instruction

 **WARNING**

- The working temperature of the device is from -30 °C to 50 °C.

- All the electronic operation should be strictly compliance with the electrical safety regulations, fire prevention regulations and other related regulations in your local region.
- Please use the power adapter, which is provided by normal company. The power consumption cannot be less than the required value.
- Do not connect several devices to one power adapter as adapter overload may cause over-heat or fire hazard.
- Please make sure that the power has been disconnected before you wire, install or dismantle the device.
- When the product is installed on wall, the device shall be firmly fixed.
- If smoke, odors or noise rise from the device, turn off the power at once and unplug the power cable, and then please contact the service center.
- If the product does not work properly, please contact your dealer or the nearest service center. Never attempt to disassemble the device yourself. (We shall not assume any responsibility for problems caused by unauthorized repair or maintenance.)



WARNING

- Do not drop the device or subject it to physical shock, and do not expose it to high electromagnetism radiation. Avoid the equipment installation on vibrations surface or places subject to shock (ignorance can cause equipment damage).
- Do not place the device in extremely hot (refer to the specification of the device for the detailed operating temperature), cold, dusty or damp locations, and do not expose it to high electromagnetic radiation.
- The device cover shall should be kept from rain and moisture.
- Exposing the equipment to direct sun light, low ventilation or heat source such as heater or radiator is forbidden (ignorance can cause fire danger).
- Do not aim the device at the sun or extra bright places. A blooming or smear may occur otherwise (which is not a malfunction however), and affecting the endurance of sensor at the same time.
- Please use the provided glove when open up the device cover, avoid direct contact with the device cover, because the acidic sweat of the fingers may erode the surface coating of the device cover.
- Please use a soft and dry cloth when clean inside and outside surfaces of the device cover, do not use alkaline detergents.
- Please keep all wrappers after unpack them for future use. In case of any failure occurred, you need to return the device to the factory with the original wrapper. Transportation without the original wrapper may result in damage on the device and lead to additional costs.
- The power supply must conform to LPS. The recommended adaptor models and manufacturers are shown as below. Use the attached adapter, and do not change the adaptor randomly.

Model	Current	Manufacturer	Standard
-------	---------	--------------	----------

MSA-C1500IC12.0-18P-US	1.5A	MOSO POWER SUPPLY TECHNOLOGY CO.,LTD	NEMA
TS-A018-120015AD	1.5A	SHENZHEN TRANSIN TECHNOLOGIES CO.,LTD	NEMA
MSA-C2000IC12.0-24P-US	2A	MOSO POWER SUPPLY TECHNOLOGY CO.,LTD	NEMA
ADS-26FSG-1212024EPCU	2A	SHENZHEN HONOR ELECTRONIC CO.,LTD	NEMA
MSA-C1500IC12.0-18P-DE	1.5A	MOSO POWER SUPPLY TECHNOLOGY CO.,LTD	CEE
ADS-25FSG-1212018GPG	1.5A	SHENZHEN HONOR ELECTRONIC CO.,LTD	CEE
MSA-C2000IC12.0-24P-DE	2A	MOSO POWER SUPPLY TECHNOLOGY CO.,LTD	CEE
ADS-24S-121224GPG	2A	SHENZHEN HONOR ELECTRONIC CO.,LTD	CEE
MSA-C1500IC12.0-18P-GB	1.5A	MOSO POWER SUPPLY TECHNOLOGY CO.,LTD	BS
ADS-25FSG-1212018GPB	1.5A	SHENZHEN HONOR ELECTRONIC CO.,LTD	BS
MSA-C2000IC12.0-24P-GB	2A	MOSO POWER SUPPLY TECHNOLOGY CO.,LTD	BS
ADS-24S-121224GPB	2A	SHENZHEN HONOR ELECTRONIC CO.,LTD	BS
MSA-C1500IC12.0-18P-AU	1.5A	MOSO POWER SUPPLY TECHNOLOGY CO.,LTD	AS
ADS-25FSG-1212018GPSA	1.5A	SHENZHEN HONOR ELECTRONIC CO.,LTD	AS
MSA-C2000IC12.0-24P-AU	2A	MOSO POWER SUPPLY TECHNOLOGY CO.,LTD	AS
MSA-C1500IC12.0-18P-BR	1.5A	MOSO POWER SUPPLY TECHNOLOGY CO.,LTD	NBR
ADS-25FSG-1212018GPBR	1.5A	SHENZHEN HONOR ELECTRONIC CO.,LTD	NBR
MSA-C2000IC12.0-24P-BR	2A	MOSO POWER SUPPLY TECHNOLOGY CO.,LTD	NBR

ADS-24S-12 1224GPBR	2A	SHENZHEN HONOR ELECTRONIC CO.,LTD	NBR
TS-A018-120015N5	1.5A	MOSO POWER SUPPLY TECHNOLOGY CO.,LTD	IS
ADS-25FSG-12 12018GPI	1.5A	SHENZHEN HONOR ELECTRONIC CO.,LTD	IS
ADS-26FSG-12 12024EPI	2A	SHENZHEN HONOR ELECTRONIC CO.,LTD	IS
ADS-24S-12 1224GPI	2A	SHENZHEN HONOR ELECTRONIC CO.,LTD	IS
ADS-26FSG-12 12024EPI	2A	SHENZHEN HONOR ELECTRONIC CO.,LTD	IS
ADS-24S-12 1224GPI	2A	SHENZHEN HONOR ELECTRONIC CO.,LTD	IS

1 Doorbell Appearance

Front and Rear Panels

You can see the camera, call button, and crews for wiring on the doorbell on the front panel and the rear panel.

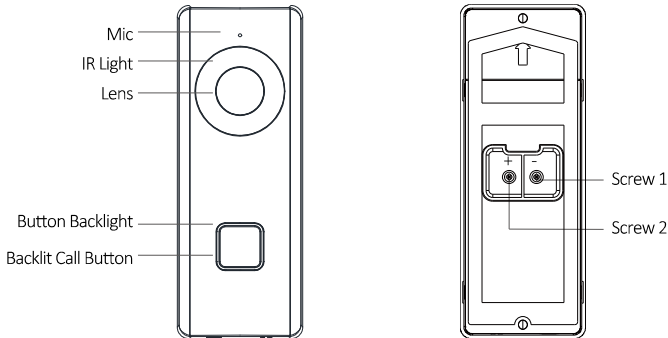

Figure 1-1 Front Panel and Rear Panel

Table 1-1 Components Description

Name	Description
IR Light	Auto light source for night vision. The lights are behind the panel.
Button Backlights	Solid blue: The doorbell is starting up and running properly.
	Cycling blue and red: Wi-Fi is not connected.
	Flashing red: The doorbell is upgrading.
	Flashing blue: The doorbell is calling the App.
	No backlight: The doorbell is speaking with the App.
Screw 1&2	These 2 screws are used to connect the power cables.

Side and Bottom Panels

You can see the camera, call button, and crews for wiring on the doorbell on the front panel and the rear panel.

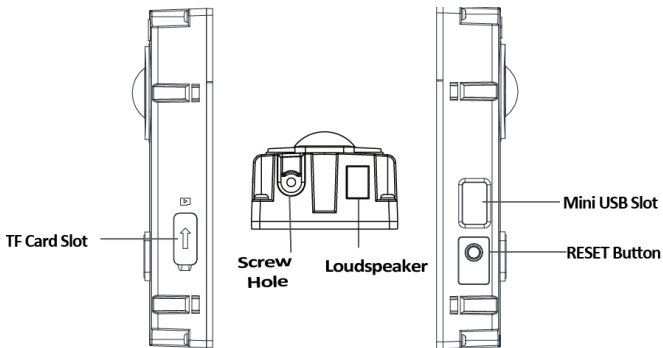

Figure 1-2 Side Panel and Bottom Panel

Table 1-2 Components Description

Name	Description
TF Card Slot	For TF card. If a TF card is used, video files will be stored in the TF card.
RESET Button	Hold the button for 15 seconds to restore the factory settings, and then enter the Wi-Fi connection mode. The call backlight cycles blue and red.

NOTE

If you do no operation in 3 minutes the doorbell will exit the Wi-Fi configuration automatically.

2 Doorbell Installation

2.1 Attach Mounting Template

Mounting template is included in the box content, and it is an auxiliary help for you to install the doorbell.

Steps

1. Determine the installation height of doorbell.

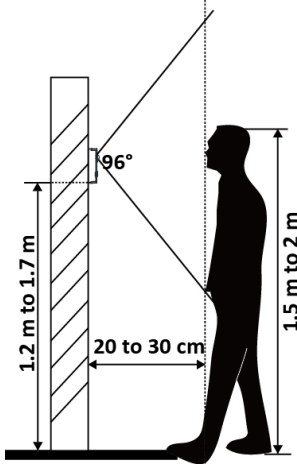

Figure 2-1 Suggested Installation Height

2. Align the cable hole on the mounting template with the cable hole on the wall.
3. Attach the mounting template on the wall.

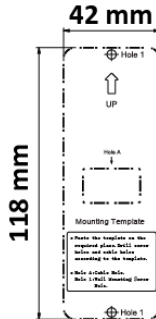

Figure 2-2 Mounting Template

2.2 Connect Power Cables

Before You Start

Make sure you have powered off the main power switch of your home.

Steps

1. Loosen the screws on the rear panel of the doorbell, put loops of power cables (included in the box content) into the screws, and then tighten them.

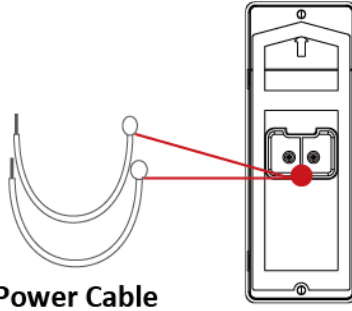

Figure 2-3 Connect Included Power Cables

2. Drill a cable hole on the wall which should be align with the hole on the mounting template.
3. Pull the power cables from the wall, and connect to the power connector.
4. Connect the power cables on the rear panel of the doorbell to the power connector (included in the box content).

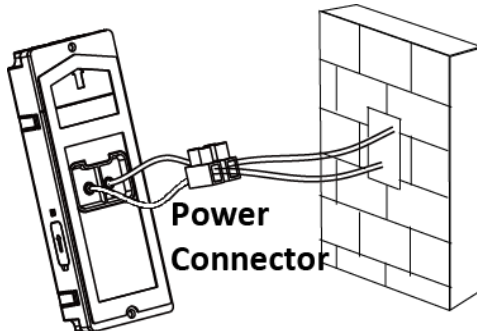

Figure 2-4 Connect Power Cables

2.3 Install TF Card (Optional)

You can use TF card to store the video files.

Steps

1. Remove the faceplate attached on the doorbell to view the front panel and side panel of the doorbell.
2. Remove the card slot cover.
3. Insert the TF card into the card slot on the side of the doorbell.
4. Cover the TF card slot.

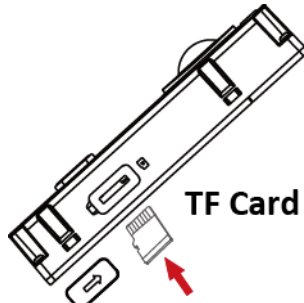

Figure 2-5 Install TF Card

NOTE

Motion detection does not support recording without the TF card.

2.4 Install Doorbell

Before You Start

- Make sure you have powered off the main power switch of your home.
- Make sure you have connected power cables of the doorbell.

Steps

1. Drill 2 holes on the wall according to the mounting template, and insert the expansion tubes into the drilled holes.

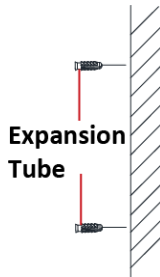

Figure 2-6 Insert Expansion Tube

2. Route the cables and insert cables and power connector into the drilled cable hole.
3. Align the screw holes on the doorbell body with drilled holes on the wall.
4. Fix the doorbell body to the wall tightly with 2 screws.

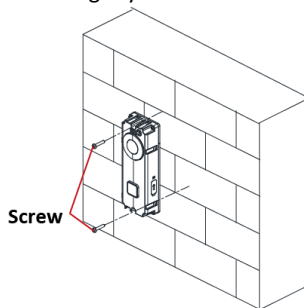

Figure 2-7 Install Doorbell

5. Put the faceplate to cover the doorbell body.
6. Use 1 set screw to fix the faceplate with the doorbell body tightly.

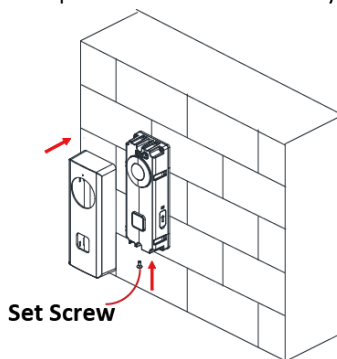

Figure 2-8 Fix Doorbell

3 Getting Started

Getting Started section provides the quick usage guide to the doorbell and its related application.

3.1 Set up Hik-Connect App

Hik-Connect App is necessary for the doorbell configuration and operation.

Before You Start

Make sure your mobile device has been connected to Wi-Fi.

Steps

1. Install Hik-Connect App and register a user account for iOS and Android.
 - 1) Search “Hik-Connect” in App Store or Google Play™ to download and install the App.



Figure 3-1 App Store/Google Play

- 2) Launch the App and follow the on-screen instructions to register a user account.
2. Start the Hik-Connect App, and log in to the App.

3.2 Set up Doorbell via App

To operate the doorbell normally, you should add the doorbell to the App, set its Wi-Fi connection via App first, and activate it.

Two ways are available in setting up doorbell via App.

NOTE

When adding doorbell to the App, the password is the activation password you set if you have activated the doorbell.

When adding doorbell to the App, the password is the admin + XXXXXX (XXXXXX is the verification code in the tag) if the doorbell is inactivated.

3.2.1 Mode 1

You can connect the Wi-Fi for the doorbell by using the camera of the doorbell to scan the QR code generated by the App. Then you could add and activate the doorbell on the App.

Connect Wi-Fi

You should set the Wi-Fi connection before adding the doorbell to the App and operating the doorbell.

Steps

1. In the Home page of the App, tap **More -> Settings -> Wi-Fi Settings** to enter the Wi-Fi settings page.
2. Input the wireless network name and password that your mobile phone has connected to.
3. Tap **Generate** to generate a QR code.
4. Use the camera of the doorbell to scan the QR code, so as to finish the Wi-Fi connection.

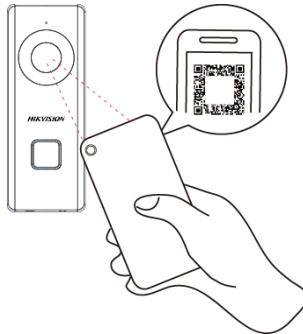

Figure 3-2 Scan the Wi-Fi QR Code

NOTE

The suggested scanning distance is 5 to 10 cm. The doorbell gives a beep for success.

Add and Activate Doorbell

Steps

1. In the App Home page, tap “+” on the upper-right corner to add the doorbell.

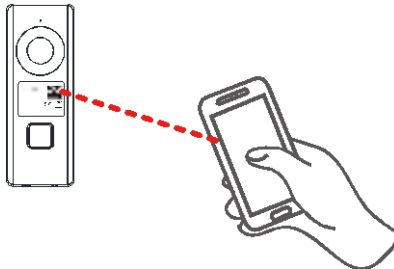

Figure 3-3 Scan the Doorbell QR Code

2. Scan the QR code or input the serial No. on the front panel of the doorbell body.
Activation page pops up after finishing the Wi-Fi connection.

 **NOTE**

The suggested scanning distance is 5 to 10 cm. The doorbell gives a beep for success.

3. Activate the doorbell.
 - 1) Tap **Set Device Password** and input a password to activate the doorbell.
 - 2) Tap **Activate** in the next page to finish activating.
4. **Optional:** Input the verification code of the doorbell in the pop-up page after activation.

 **NOTE**

This step is only necessary for adding the doorbell by inputting the serial No..

3.2.2 Mode 2

You can scan the QR code on the doorbell via the App to add the doorbell, connect the Wi-Fi for it, and activate the doorbell in sequence.

Steps

1. In the App Home page, tap “+” on the upper-right corner to add the doorbell.

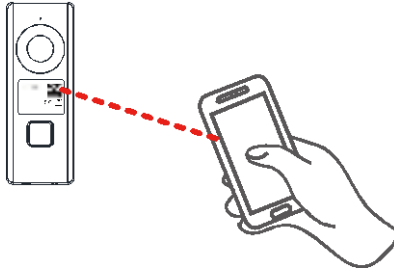

Figure 3-4 Scan the Doorbell QR Code

2. Scan the QR code or input the serial No. on the front panel of the doorbell body.
Network connection page pops up automatically.

 **NOTE**

The suggested scanning distance is 5 to 10 cm. The doorbell gives a beep for success.

3. Connect Wi-Fi.
 - 1) Tap **Connect to a Network**.
 - 2) Input the wireless network name and password that your mobile phone has connected to.
 - 3) Hold the **RESET** button on the side panel of the doorbell body for 5 seconds.

You will hear the voice prompt “Start configuring Wi-Fi”.

4) Tap **Next** in 3 minutes to start the Wi-Fi connection.

Activation page pops up after finishing the Wi-Fi connection.

4. Activate the doorbell.

1) Tap **Set Device Password** and input a password to activate the doorbell.

2) Tap **Activate** in the next page to finish activating.

5. **Optional:** Input the verification code of the doorbell in the pop-up page after activation.



NOTE

This step is only necessary for adding the doorbell by inputting the serial No..

4 Doorbell Operation

Via the Hik-Connect App, you can realize some certain functions of the doorbell (including, but not limited to, live view, and remote playback).

Video Intercom

Press **Call Button** on the doorbell.

You can accept the call via the Hik-Connect App, get the live view of the doorbell, and capture the snapshots.

Live View

Launch the Hik-Connect App and you can get the live view of the connected devices.

Playback

Launch the Hik-Connect App, tap a connected device and tap Gallery to play back.

Recording

Check the TF card status by tapping Storage Status in the Device Settings page.

If the TF card status displays as Uninitialized, tap to initialize it. The status will then change to Normal. You can then start recording any event triggered video in the camera of the doorbell such as motion detection video.

Alarm Notification

Launch the Hik-Connect App and tap Message to see the alarm messages, such as motion detection alarm message.



NOTE

- The messages will be pushed automatically by enabling Message Push Notification.
 - The App can receive the triggered alarm automatically when the doorbell is powered on by enabling Auto-Receive Alarm after Powering on.
-

0104621080116



First Choice for Security Professionals

UD08001B

www.hikvision.com