

AUTODOME IP starlight 5000i

www.boschsecurity.com



BOSCH
Invented for life



- ▶ Starlight camera technology with excellent low-light performance
- ▶ 120dB dynamic range lets you capture details in overexposed situations with confidence
- ▶ Intelligent streaming, IDNR and H.265 reduce bit rate by up to 80%
- ▶ Built-in Essential Video Analytics to trigger relevant alerts and quickly retrieve data
- ▶ High resolution bubble to ensure maximum effective resolution output

Specially designed and tuned for applications requiring surveillance in scenes with varying light levels, the AUTODOME IP starlight 5000i camera has an integrated 30X optical zoom to identify people at a maximum distance of 183 m (600 ft) with minimal loss of detail.

Functions

Low-light performance

The latest sensor technology, combined with sophisticated noise suppression and a High dynamic range of 120 dB, results in an exceptional sensitivity in color. The camera continues to provide excellent color performance even with a minimum of ambient light.

Pre-programmed user modes

The camera has several pre-configured scene modes with the best settings for various applications. With one click, users can optimize image settings to match the camera's lighting conditions. Users can also configure individual image settings.

- Standard: For indoor fluorescent lighting.
- Sodium-lighting: For scenarios where the video is captured under sunlight in the day or under sodium vapor lamp at night.

- Vibrant: For enhanced contrast, sharpness, and saturation

H.265 high-efficiency video encoding

The camera is designed on the most efficient and powerful H.264 and H.265/HEVC encoding platform. The camera is capable of delivering high-quality and high-resolution video with very low network load. With a doubling of encoding efficiency, H.265 is the new compression standard of choice for IP video surveillance systems.

Intelligent streaming

Smart encoding capabilities, together with Intelligent Dynamic Noise Reduction technology and analytics, make the bandwidth consumption drop to extremely low levels. Only relevant information in the scene, such as motion or objects found with the analytics, are encoded.

Support for H.264 and H.265 with Encoder Regions

Set a region in the field of view and define a specific encoder profile to it. This setting reduces the bitrate of the stream further than intelligent streaming alone.

Recording and storage management

Recording management can be controlled by the Bosch Video Recording Manager application, or the camera can use local storage and iSCSI targets directly without any recording software.

A memory card with a maximum of 32 GB (microSDHC) / 2 TB (microSDXC) can be used for recording "at the edge" or for Automatic Network Replenishment (ANR) technology to improve the overall recording reliability.

Pre-alarm recording in RAM reduces bandwidth consumption on the network and extends the effective life of the memory card.

Essential Video Analytics on the edge

The camera includes the latest release of Essential Video Analytics application from Bosch for use on Pre-positions.

The Essential Video Analytics application provides reliable video analytics for small and medium business, large retail stores, commercial buildings, and warehouses.

Advanced tasks like multiple line crossing, loitering, idle / removed object detection, crowd density estimation, occupancy and people counting are available for live alarming and forensic search. Object filters based on size, speed, direction, aspect ratio, and color can be defined.

A simplified calibration mode reduces installation time significantly, because you only need to enter the installation height once for each camera, independent of pre-positions.

After the camera is calibrated, the analytics engine can automatically classify objects as upright person, car, bike, or truck.

Sophisticated alarm responses

The camera supports advanced alarm control that uses sophisticated rules-based logic to determine how to manage alarms. In its most basic form, a "rule" could define which input(s) should activate which output(s). In a more complex form, inputs and outputs can be combined with pre-defined or user-specified commands to perform advanced camera functions.

Superior privacy masking

The camera allows for a total of 32 individual privacy masks, with up to eight masks displayed in the same scene. Each mask can be programmed with eight corners. Each mask changes size and shape smoothly and quickly, ensuring that the covered object cannot be seen.

With the AUTO Privacy Mask, the color of the Privacy Mask will adapt to the color of the surroundings.

DORI coverage

DORI (Detect, Observe, Recognize, Identify) is a standard system (EN-62676-4) for defining the ability of a camera to distinguish persons or objects within a covered area. The maximum distance at which a camera/lens combination can meet these criteria is shown below:

	DORI definition	Distance	
		WIDE 1X	TELE 30X
Detect	25 px/m (8 px/ft)	65 m (213 ft)	1833 m (6014 ft)
Observe	63 px/m (19 px/ft)	26 m (85 ft)	727 m (2385 ft)
Recognize	125 px/m (38 px/ft)	13 m (43 ft)	367 m (1204 ft)
Identify	250 px/m (76 px/ft)	7 m (23 ft)	183 m (600 ft)

Data security

Special measures are necessary to ensure the highest level of security for device access and data transport.

On initial setup, the camera is only accessible over secure channels. You must set a service-level password in order to access camera functions.

Web browser and viewing client access can be protected using HTTPS or other secure protocols that support state-of-the-art TLS 1.2 protocol with updated cipher suites including AES encryption with 256 bit keys. No software can be installed in the camera, and only authenticated firmware can be uploaded. A three-level password protection with security recommendations allows users to customize device access. Network and device access can be protected using 802.1x network authentication with EAP/TLS protocol. Superior protection from malicious attacks is guaranteed by the Embedded Login Firewall, on-board Trusted Platform Module (TPM) and Public Key Infrastructure (PKI) support.

The advanced certificate handling offers:

- Self-signed unique certificates automatically created when required
- Client and server certificates for authentication
- Client certificates for proof of authenticity
- Certificates with encrypted private keys

Software sealing

After camera configuration is set and should not be changed, system administrators can enable software protection that seals the camera configuration. Any change of the sealing status and any change to static configuration, accidentally or intentional, will break the seal. The camera then sends an alarm message that the video management system can use to start an appropriate alarm scenario. The camera creates a separate log file of all changes that have an effect on the sealing status.

System integration and ONVIF conformance

The camera conforms to the ONVIF Profile S, ONVIF Profile G and ONVIF Profile T specifications. For H.265 configuration, the camera supports Media Service 2, which is part of ONVIF Profile T. Compliance with these standards guarantees interoperability between network video products regardless of manufacturer.

Third-party integrators can easily access the internal feature set of the camera for integration into large projects. Visit the Bosch Integration Partner Program (IPP) website (ipp.boschsecurity.com) for more information.

PTZ drive and mechanism

The camera supports 256 pre-positions and two styles of Guard Tours: Pre-position and Record/Playback. The Pre-position tour has capability for up to 256 pre-positions with a configurable dwell time between pre-positions and can be customized as to the order and the frequency that each Pre-position is visited. The camera also provides support for two (2) recorded tours, which have a total duration of 15 minutes of movements. These are recorded macros of an operator's movements, including pan, tilt, and zoom activities, and can be played back in a continuous manner.

Pan and tilt preset repeatability are accurate to within ± 0.1 degrees to ensure that the correct scene is captured every time. The camera delivers maximum pan speed of 300 degrees per second and maximum tilt speed of 200° degrees per second. The camera is capable of manual speeds (pan and tilt) of 0.1 to 120 degrees per second. The camera provides a pan range of up to 360 degrees continuous rotation.

Snap to zoom

Drawing a box in the image will trigger the camera to zoom to the correct position.

Ease of installation and servicing

The camera has been designed for quick and easy installation, a key feature from Bosch IP video products. All housings feature recessed screws and latches for increased tamper resistance. Bosch designed the camera with the knowledge that field cables and mounts are installed before the camera is mounted. The installation concept allows a single person to connect the cables directly to the camera without re-routing cables. The camera is easily secured to the mount with a single screw. The pendant housings are rated to provide IP66 protection and offer an operating temperature range down to -40 °C (-40 °F). The pendant camera comes fully assembled with a sunshield and ready for wall or pipe applications with the proper mounting hardware (sold separately).

Bosch offers a full complement of hardware and accessories (sold separately) for wall, corner, mast, roof, pipe mount, and in-ceiling applications for indoor and outdoor environments, which allow the camera to be adapted easily to individual site requirements.

Project Assistant

Project Assistant by Bosch is the market's most easy-to-use app for initial installation and basic configuration of IP cameras. Off-site and without connection to the camera, basic configurations can already be covered and shared with colleagues. On-site, these pre-configurations can simply be pushed

onto the camera, making the installation procedure easier and less time consuming. Already configured cameras can be integrated as well. The app allows easy viewing and adjustment of the camera's field of view. The app automatically generates a comprehensive report of the commissioned cameras.

Certifications and approvals

HD standards

- Complies with the SMPTE 274M-2008 Standard in:
 - Resolution: 1920x1080
 - Scan: Progressive
 - Color representation: complies with ITU-R BT.709
 - Aspect ratio: 16:9
 - Frame rate: 25 and 30 frames/s
- Complies with the 296M-2001 Standard in:
 - Resolution: 1280x720
 - Scan: Progressive
 - Color representation: complies with ITU-R BT.709
 - Aspect ratio: 16:9
 - Frame rate: 25 and 30 frames/s

Marking	Applicable Standard
cULus	<ul style="list-style-type: none"> • UL60950-1/-22 (ed 2) (Includes CSA 22.2 No. 60950-1/-22)
FCC Part 15 (USA)	<ul style="list-style-type: none"> • 47CFR Part 15 • ICES-003 (Canada)
CE (Europe)	<p>Electromagnetic Compatibility (EMC) Directive</p> <ul style="list-style-type: none"> • EN55032:2012/AC:2013 • EN 50130-4:2011/A1:2014 • EN 61000-3-2:2014 • EN 61000-3-3:2013 <p>Product Safety: Low Voltage Directive (IECEE CB scheme certificate and report are required)</p> <ul style="list-style-type: none"> • EN 60950-1:2006+A11:2009+A1:2010+A12:2011+A2:2013 (with national differences) • IEC 60950-1/-22 (ed 1)
Other labels / markings	<ul style="list-style-type: none"> • RCM, EAC, WEEE, China RoHS, BIS

EAC = NDP-5512-Z30, NDP-5512-Z30C

For a full list of all related certifications/standards, refer to the Product Tests Report, available on the online catalog, on the Documents tab of the product page for your device. If the document is unavailable on the product page, contact your sales representative.

Region	Regulatory compliance/quality marks	
Europe	CE	Declaration of Conformity (DoC) - AUTODOME IP starlight 5000i,-IR
USA	UL	AUTODOME IP starlight 5000i

Installation/configuration notes

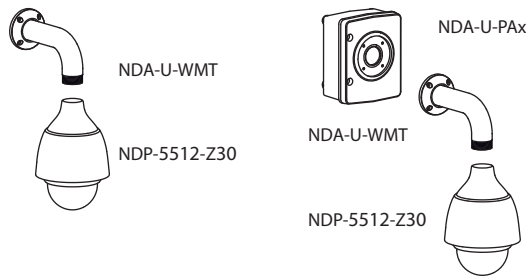

Wall mount; Wall mount with surveillance cabinet (IP66)

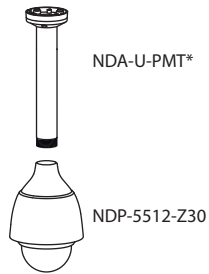

Pendant Pipe mount
* NDA-U-PMTE: optional 50cm / 20" extension pipe

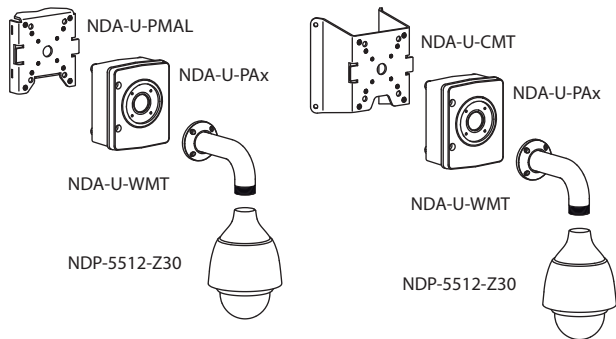

Pole mount (IP66); Corner mount (IP66)

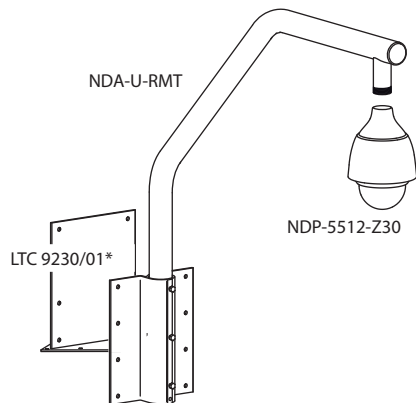

Roof mount (IP66)
* optional for flat roof mount

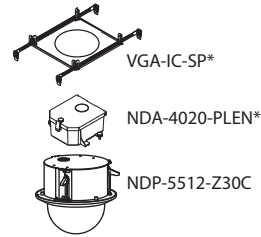

In-ceiling mount
* optional

For more options, see Quick Selection Guide: Modular camera mounts & accessories.

Technical specifications

Imager	1/2.8" progressive scan CMOS
Effective Picture Elements	1945 x 1097 (2.13 MP)
Lens	30x zoom 4.5 mm - 135 mm (F1.6 - F4.4)
Optical Zoom Field of View (FOV)	2.4° - 60.9°
Focus	Automatic with manual override
Iris	Automatic with iris priority feature
Digital Zoom	16x

Video performance - Sensitivity

(3100K, reflectivity 89%, 1/30, F1.6, 30 IRE)

Color	0.0186 lux
Mono	0.004 lux

Additional Camera Settings

Gain control	AGC, Variable 6 dB to 71 dB
Electronic Shutter Speed (AES)	0.64 sec to 1/666666 sec
Signal-to-Noise Ratio (SNR)	>55 dB
Day/Night switch	Automatic IR cut filter
Backlight compensation (BLC)	On / Off / Intelligent Auto Exposure (IAE)
White balance	Basic auto, Standard auto, Sodium lamp auto, Dominant color auto, Manual
Day/Night (mode)	Monochrome, Color, Auto
Defog mode feature	Improves visibility when viewing foggy or other low-contrast scenes.

Dynamic range	
High dynamic range	120 dB WDR
Measured according to IEC 62676 Part 5	107 dB WDR
Video content analysis	
Analysis type	Essential Video Analytics
Configurations	Silent VCA / Profile1 - 16
Alarm rules (combinable)	Any object Object in field Crossing line Entering field Leaving field Loitering Following route Idle object Removed object Counter Occupancy Crowd detection Condition change Similarity search Tampering
Object filters	Duration Size Aspect ratio v/h Speed Direction Color Object classes (Upright persons, Bikes, Cars, Trucks)
Calibration	Automatic self-calibrating when height is set
Mechanical	
Pan/Tilt Modes	Normal: 0.1°/s - 120°/s Turbo: Pan: 0.1°/s - 300°/s; Tilt: 0.1°/s - 200°/s
Pre-position Speed	Pan: 300°/s Tilt: 200°/s
Pan Range	360° continuous
Tilt Angle	-90° to 0° (Auto-flip 180°)
Pre-position Accuracy	± 0.1° typ.
Pre-positions	256
Tours	Two (2) types of tours: <ul style="list-style-type: none"> Recorded tours: two (2), maximum total duration 15 minutes (depending on the amount of commands sent during recording) Pre-position tour: one (1), consisting of up to 256 scenes consecutively, and one (1), customized up to 64 scenes

Electrical

Input voltage	24 VAC and PoE+
Power consumption	14 W (heater off) / 24 W (heater on)

Network

Video compression	H.265 H.264 M-JPEG
Streaming	Four (4) streams: Two (2) configurable streams in H.264 or H.265 One (1) I-frames-only stream based on first stream One (1) M-JPEG Stream
Frame rate	60fps at all resolutions
IP delay (typical)	60 fps: 200 ms

Resolution (H x V)

1080p Full HD (16:9)	1920 x 1080
720p HD (16:9)	1280 x 720
1.3MP (5:4)	1280 x 1024 cropped
D1 4:3 (cropped) (4:3)	704 x 576
640x480 (4:3)	640x480 cropped
432p SD	768 x 432
288p SD	512 x 288

Bitrate	The average typical optimized bitrate in kbits/second for various frame rates is shown in the following table:	
Video compression	H.265	
IPS	1080p	720p
60	1649	1249
30	1413	1096
15	1157	902
10	1075	841
5	746	597
2	407	343

Ethernet	10/100BASE-T
Encryption	TLS 1.0, SSL, DES, 3DES, AES

Protocols	IPv4, IPv6, UDP, TCP, HTTP, HTTPS, RTP/RTCP, IGMP V2/V3, ICMP, ICMPv6, RTSP, FTP, ARP, DHCP, APIPA (Auto-IP, link local address), NTP (SNTP), SNMP (V1, V3, MIB-II), 802.1x, DNS, DNSv6, DDNS (DynDNS.org, selfHOST.de, no-ip.com), SMTP, iSCSI, UPnP (SSDP), DiffServ (QoS), LLDP, SOAP, Dropbox™, CHAP, digest authentication
Interoperability	ONVIF Profile S, ONVIF Profile G, ONVIF Profile T, GB/T 28181

Local Storage

Memory card slot	Support a memory card with a maximum of 32 GB (microSDHC) / 2 TB (microSDXC) (user-supplied). (An SD card of Class 6 or higher is recommended for HD recording.)
------------------	--

Miscellaneous

Sector/Titling	16 independent sectors with 20 characters per title
Privacy Masks	32 individually configurable privacy masks
Privacy Masks pattern	Black, White, Gray, Auto (average background color)
Supported Languages	English, German, Spanish, French, Italian, Dutch, Polish, Portuguese, Russian, Japanese, Chinese (simplified)

Audio

Compression	G.711, 8kHz sampling rate L16, 16kHz sampling rate AAC, 16kHz sampling rate
Interface	1/1 Channel In/Out

User Connections

Power	RJ45 10/100 Base-T PoE+ (IEEE 802.3at, class 4 standard) 21-30 VAC, 50/60 Hz
Alarm Inputs	2
Alarm Outputs	1 relay output 5 VDC, 150 mA max.
Audio	1x mono line in, 1x mono line out
• Signal line in	94 kOhm typical, 1 Vrms max.
• Signal line out	1 kOhm typical, 1 Vrms max.

Communications / Software Control

Serial protocols	Bosch OSRD, Pelco P/D, Forward Vision, and Cohu Note: A separate license (MVS-FCOM-PRCL) is required.
------------------	---

Environmental (pendant model)

Ingress Protection Rating/ Standard	IP66
IK Rating	IK10
Operating temperature	-40 °C to +60 °C (-40 °F to +140 °F)
Humidity	0% to 100% RH, condensing
Storage temperature	-40 °C to +60 °C (-40 °F to +140 °F)

Environmental (in-ceiling model)

Ingress Protection Rating/ Standard	IP51
Operating temperature	-10 °C to +60 °C (+14 °F to +140 °F)
Humidity	Up to 90% RH, non-condensing
Storage temperature	-40 °C to +60 °C (-40 °F to +140 °F)

Construction (pendant model)

Dimensions (D x H)	207 mm x 303.6 mm (8.15 in x 11.95 in)
Weight	3.25 kg (7.17 lb)
Construction Material	Housing: Aluminum Sunshield: Outdoor Grade Plastic Bubble: Polycarbonate, anti-reflective, anti-static, anti-scratch, hydrophobic, UV protective
Standard Color	White (RAL 9003)

Construction (in-ceiling model)

Dimensions (DIA x H)	198 mm x 176.6 mm (7.8 in x 6.95 in)
Weight	2.1 kg (4.63 lb)
Construction material	Housing: SPCC Trim ring: PC/ABS Bubble: Polycarbonate
Standard color	White (RAL 9003)

Dimensional Drawings

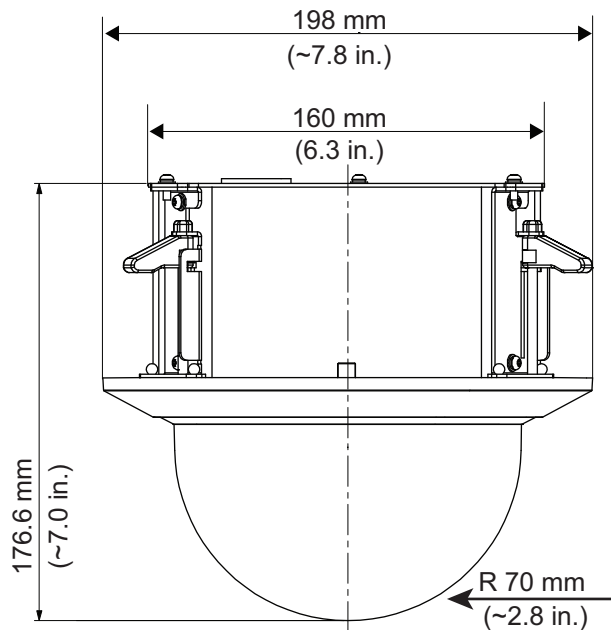

In-ceiling model

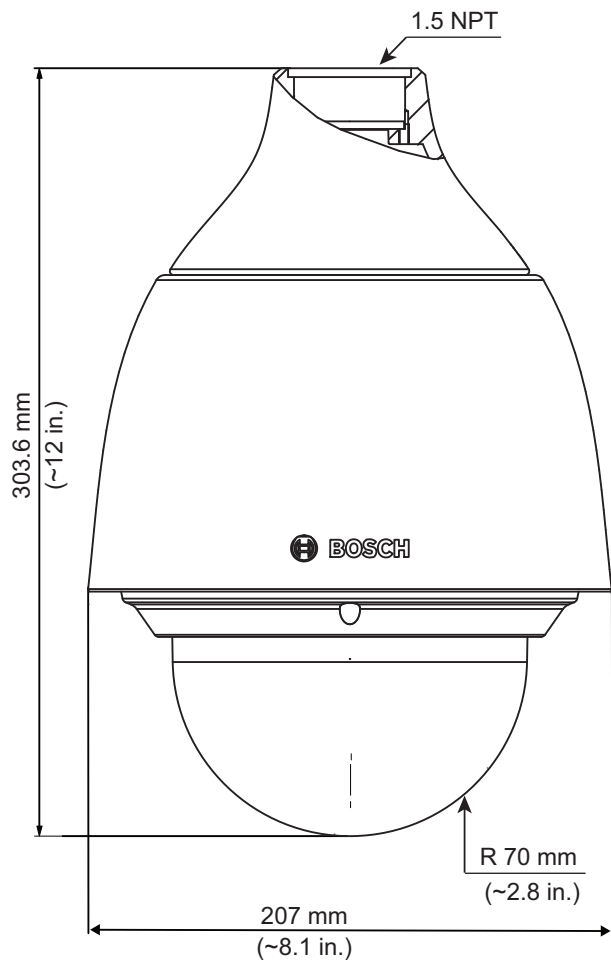

Ordering information

NDP-5512-Z30C-P PTZ 2MP HDR 30x clear in-ceiling
In-ceiling IP PTZ dome camera; 1080p60; 30X optical, 4x4 digital zoom; 120dB HDR; starlight imaging; IAE; EVA; PoE; Intelligent Streaming; clear, high-resolution, coated bubble. Dual power options.
Order number **NDP-5512-Z30C-P**

EWE-AD5HD-IW 12mths wrty ext AUTODOME IP 5000 HD
12 months warranty extension without moving parts, wear parts are excluded
Order number **EWE-AD5HD-IW**

NDP-5512-Z30C PTZ 2MP HDR 30x clear in-ceiling
In-ceiling IP PTZ dome camera; 1080p60; 30X optical, 4x4 digital zoom; 120dB HDR; starlight imaging; IAE; EVA; PoE; Intelligent Streaming; clear, high-resolution, coated bubble. Dual power options.
Order number **NDP-5512-Z30C**

EWE-AD5HD-IW 12mths wrty ext AUTODOME IP 5000 HD
12 months warranty extension without moving parts, wear parts are excluded
Order number **EWE-AD5HD-IW**

NDP-5512-Z30-P PTZ 2MP HDR 30x clear IP66 pendant
IP PTZ dome camera; 1080p60; 30X optical, 4x4 digital zoom; 120dB HDR; starlight imaging; IAE; EVA; PoE; Intelligent Streaming; clear, high-resolution, coated bubble. Dual power options.
Order number **NDP-5512-Z30-P**

EWE-AD5HD-IW 12mths wrty ext AUTODOME IP 5000 HD
12 months warranty extension without moving parts, wear parts are excluded
Order number **EWE-AD5HD-IW**

NDP-5512-Z30 PTZ 2MP HDR 30x clear IP66 pendant
IP PTZ dome camera; 1080p60; 30X optical, 4x4 digital zoom; 120dB HDR; starlight imaging; IAE; EVA; PoE; Intelligent Streaming; clear, high-resolution, coated bubble. Dual power options.
Order number **NDP-5512-Z30**

EWE-AD5HD-IW 12mths wrty ext AUTODOME IP 5000 HD
12 months warranty extension without moving parts, wear parts are excluded
Order number **EWE-AD5HD-IW**

Accessories

UPA-2450-50 PSU, 220VAC 50Hz, 24VAC 50VA out
Indoor power supply for camera. 220 VAC, 50 Hz in;
24 VAC, 50 VA out
Order number **UPA-2450-50**

UPA-2450-60 PSU, 120VAC 60Hz, 24VAC 50VA out
Indoor power supply for camera. 120 VAC, 60 Hz In;
24 VAC, 50 VA Out
Order number **UPA-2450-60**

NPD-6001B Midspan, 60W, single port, AC in
60 W indoor midspan for cameras without illuminators
Order number **NPD-6001B**

NDA-U-PA0 Surveillance cabinet 24VAC
Surveillance cabinet, 24 VAC input, 24 VAC output,
IP66
Order number **NDA-U-PA0**

NDA-U-PA1 Surveillance cabinet 120VAC
Surveillance cabinet, 100 - 120 VAC 50/60 Hz input,
24 VAC output, IP66
Order number **NDA-U-PA1**

NDA-U-PA2 Surveillance cabinet 230VAC
Surveillance cabinet, 230 VAC input, 24 VAC output,
IP66
Order number **NDA-U-PA2**

NDA-U-CMT Corner mount adapter
Universal corner mount, white
Order number **NDA-U-CMT**

NDA-U-PMAL Pole mount adapter large
Universal pole mount adapter, white; large
Order number **NDA-U-PMAL**

NDA-U-PMAS Pole mount adapter small
Pole mount adapter small
Universal pole mount adapter, white; small.
Order number **NDA-U-PMAS**

NDA-U-PMT Pendant pipe mount, 12" (31cm)
Universal pipe mount for dome cameras, 31 cm, white
Order number **NDA-U-PMT**

NDA-U-PMTE Pendant pipe extension, 20" (50cm)
Extension for universal pipe mount, 50 cm, white
Order number **NDA-U-PMTE**

NDA-U-PSMB Pendant wall/ceiling mount SMB
Surface mount box (SMB) for wall mount or pipe
mount.
Order number **NDA-U-PSMB**

NDA-U-WMP Wall mount plate
Back plate for universal wall mount, corner mount and
pole mount, white, IP66
Order number **NDA-U-WMP**

NDA-U-WMT Pendant wall mount
Universal wall mount for dome cameras, white
Order number **NDA-U-WMT**

NDA-U-RMT Pendant parapet mount
Universal roof mount for dome cameras, white
Order number **NDA-U-RMT**

LTC 9230/01 Parapet roof mount adapter
Flat Roof Mount Adapter for mounting a unit in an
upright position on a flat surface.
Order number **LTC 9230/01**

VGA-IC-SP Suspended ceiling support kit, 7"
Suspended ceiling support kit for dome cameras.
Aperture Ø177 mm (Ø7 in). Maximum supported
weight 11.3 kg (25 lb).
Order number **VGA-IC-SP**

MNT-ICP-ADC Drop ceiling support kit for AUTO-DOME
Suspension ceiling support kit for AUTODOME IP
4000/5000/7000 AND VG5-100/600 series in-ceiling
cameras
Order number **MNT-ICP-ADC**

NDA-4020-PLEN Plenum box for PTZ dome
In-ceiling housing for plenum spaces for AUTODOME
IP 4000i and AUTODOME IP 5000i cameras. Available
in specific regions only.
Order number **NDA-4020-PLEN**

NDA-5020-PTBL Tinted bubble for PTZ dome
Tinted bubble for pendant models of AUTODOME IP
5000i cameras.
Order number **NDA-5020-PTBL**

NEZ-A5-BUB-CTIP Bubble, tinted, for in-ceiling model
Tinted bubble for in-ceiling models of AUTODOME IP
5000i cameras.
Order number **NEZ-A5-BUB-CTIP**

VG4-SFPSCKT ETHERNET TO SFP INTERFACE KIT
Ethernet media converter video transmitter/data
receiver fiber optic kit for AUTODOME cameras, for
MIC-IP-PSU for MIC analog cameras and for the
Surveillance cabinets (NDA-U-PA0, NDA-U-PA1 and
NDA-U-PA2).
Order number **VG4-SFPSCKT**

SFP-2 Fiber module, multimode, 1310nm, 2LC
SFP Fiber Optic Module, 2 km (1.2 miles), 2 LC
connectors.
Multi-mode
1310 nm
Order number **SFP-2**

SFP-3 Fiber module, single-mode, 1310nm, 2LC
SFP Fiber Optic Module, 20 km (12.4 miles), 2 LC
connectors.
Single-mode
1310 nm
Order number **SFP-3**

SFP-25 Fiber module, 1310/1550nm, 1SC
SFP Fiber Optic Module, 2 km (1.2 miles), 1 SC
connector

Multi-mode
1310/1550 nm
Order number **SFP-25**

SFP-26 Fiber module, 1550/1310nm, 1SC
SFP Fiber Optic Module, 2 km (1.2 miles), 1 SC
connector
Multi-mode

1550/1310 nm
Order number **SFP-26**

Software Options

MVS-FCOM-PRCL License key for serial protocol
Serial Protocol Software License (e-license) for IP
Cameras
Order number **MVS-FCOM-PRCL**

Represented by:

Europe, Middle East, Africa:
Bosch Security Systems B.V.
P.O. Box 80002
5600 JB Eindhoven, The Netherlands
Phone: + 31 40 2577 284
emea.securitysystems@bosch.com
emea.boschsecurity.com

Germany:
Bosch Sicherheitssysteme GmbH
Robert-Bosch-Ring 5
85630 Grasbrunn
Germany
www.boschsecurity.com

North America:
Bosch Security Systems, LLC
130 Perinton Parkway
Fairport, New York, 14450, USA
Phone: +1 800 289 0096
Fax: +1 585 223 9180
onlinehelp@us.bosch.com
www.boschsecurity.us

Asia-Pacific:
Robert Bosch (SEA) Pte Ltd, Security Systems
11 Bishan Street 21
Singapore 573943
Phone: +65 6571 2808
Fax: +65 6571 2699
apr.securitysystems@bosch.com
www.boschsecurity.asia