

AXIS C1410 Network Mini Speaker

User Manual

AXIS C1410 Network Mini Speaker

Solution overview

Solution overview



To watch this video, go to the web version of this document.

www.axis.com/products/online-manual/57927

An overview of how network audio works.

AXIS C1410 Network Mini Speaker

Find the device on the network

Find the device on the network

To find Axis devices on the network and assign them IP addresses in Windows®, use AXIS IP Utility or AXIS Device Manager. Both applications are free and can be downloaded from axis.com/support.

For more information about how to find and assign IP addresses, see the document *How to assign an IP address and access your device* on the device page at axis.com.

Browser support

You can use the device with the following browsers:

	Chrome™	Firefox®	Edge®	Safari®
Windows®	recommended	x	x	
OS X®	recommended			x
Other operating systems	x	x		

If you need more information about recommended browsers, go to axis.com/browser-support.

AXIS C1410 Network Mini Speaker

Access the device

Access the device

1. Open a browser and enter the IP address or host name of the Axis device.

If you have a Mac computer (OS X), go to Safari, click Bonjour and select the device from the drop-down list. To add Bonjour as a browser bookmark, go to **Safari > Preferences**.

2. Enter the username and password. If you access the device for the first time, you must set the root password. See *Set a new password for the root account on page 4*.

Set a new password for the root account

Important

The default administrator username is **root**. If the password for root is lost, reset the device to factory default settings.

1. Type a password. Follow the instructions about secure passwords. See *Secure passwords on page 4*.
2. Retype the password to confirm the spelling.
3. Click **Save**. The password has now been configured.

Secure passwords

Important

Axis devices send the initially set password in clear text over the network. To protect your device after the first login, set up a secure and encrypted HTTPS connection and then change the password.

The device password is the primary protection for your data and services. Axis devices do not impose a password policy as they may be used in various types of installations.

To protect your data we strongly recommend that you:

- Use a password with at least 8 characters, preferably created by a password generator.
- Don't expose the password.
- Change the password at a recurring interval, at least once a year.

AXIS C1410 Network Mini Speaker

Additional settings

Additional settings

Change the root password

1. Log in to the product's webpage and go to **System > Users**.
2. For the root user, click **Edit**.
3. Enter a new password and save.

Set up a new zone

1. Log in to the audio device that you want to set as the leader in the audio system.
2. Go to **Audio > System settings**.
3. Edit the leader audio device:
 - 3.1 Click the pencil.
 - 3.2 Enter audio device name and enter username and password.
 - 3.3 Click **Apply**
4. If possible, change to **Multicast**.
5. Add audio devices to the audio system:
 - 5.1 Under **Available audio devices**, click the plus sign to add an audio device to the zone. If your device is not listed, click **Add device manually** to add the device.
 - 5.2 For each audio device, set the audio device name and enter username and password for that device.
 - 5.3 Click **Apply**.

Set volume and gain

Volume

1. Go to **Audio > System overview**.
2. Use the slider **System** under **Volume** to set the system volume.

Axis Audio Player

1. Go to **Services and apps** and open **Axis Audio Player**.
2. Set the volume level for system, announcements and music.

Note

The maximal volume for announcements and music can never be higher than the maximal volume for the system.

Gain

1. Go to **Audio > Device settings**.
2. On the **Output**, set the **Output gain**.
3. On the **Input** tab, set the **Input gain**.

AXIS C1410 Network Mini Speaker

Additional settings

4. Go to **Audio > System overview**.
5. Use the sliders beside a follower to adjust the gain for an audio device.

Calibrate and run remote speaker test

The speaker test is a test that can be initiated from a remote location to verify that the speaker is working as intended. For more information, see *Speaker test on page 17*.

Note

During calibration, it is recommended that someone is physically present at the installation site to listen to the test tones and ensure that the test tones are not muffled or blocked by any unintended obstructions in the speaker's acoustic path.

Calibrate the audio device:

1. Go to **Audio > Device settings**.
2. Click **Calibrate** to calibrate the audio device.

Once the Axis product is calibrated, the speaker test can be run at any time:

1. Go to **Audio > Audio settings**.
2. Click **Test** to run the speaker test.

Note

It is also possible to run the calibration by pressing the control button. See *Product overview on page 23* to identify the control button.

Prepare an audio clip link

Audio clips can be set to play when an event occurs.

To prepare an audio clip link:

1. Go to **Audio > Audio clips**.
2. Click  for an audio clip.
3. Set the volume and number of times to repeat the clip.
4. Click the copy icon to copy the link.

Set up direct SIP (P2P)

VoIP (Voice over IP) is a group of technologies that enables voice and multimedia communication over IP networks. For more, see *Voice over IP (VoIP) on page 17*.

In this product VoIP is enabled through the SIP protocol. For more information about SIP, see *Session Initiation Protocol (SIP) on page 17*.

There are two types of setups for SIP. Peer-to-peer is one of them. Use peer-to-peer when the communication is between a few user agents within the same IP network and there is no need for extra features that a PBX-server could provide. For information on how to set it up, see *Peer-to-peer SIP (P2PSIP) on page 17*.

1. Go to **VoIP > SIP settings** and select **Enable SIP**.
2. In **Call timeout**, set the number of seconds that a call will last before it ends if there is no answer.
3. To allow the device to receive incoming calls, select **Allow incoming calls**.

AXIS C1410 Network Mini Speaker

Additional settings

4. Set the number of seconds before timeout for incoming calls.
5. Click **Save**.
6. In **Port settings**, enter the **SIP port number** and **SIP TLS port number**.

Note

- **SIP port** – for SIP sessions. Signalling traffic through this port is non-encrypted. The default port number is 5060.
 - **SIP TLS port** – for SIPS and TLS secured SIP sessions. Signalling traffic through this port is encrypted with Transport Layer Security (TLS). The default port number is 5061.
 - **RTP start port** – Enter the port used for the first RTP media stream in a SIP call. The default start port for media transport is 4000. Some firewalls might block RTP traffic on certain port numbers. A port number must be between 1024 and 65535.
7. Click **Save**.
 8. In **NAT traversal**, select the protocols you want to enable for NAT traversal.

Note

Use NAT traversal when the device is connected to the network from behind a NAT router or a firewall. For more information see *NAT traversal on page 19*.

Set up SIP through a server (PBX)

VoIP (Voice over IP) is a group of technologies that enables voice and multimedia communication over IP networks. For more, see *Voice over IP (VoIP) on page 17*.

In this product VoIP is enabled through the SIP protocol. For more information about SIP, see *Session Initiation Protocol (SIP) on page 17*.

There are two types of setups for SIP. A PBX-server is one of them. Use a PBX-server when the communication should be between an infinite number of user agents within and outside the IP network. Additional features could be added to the setup depending on the PBX-provider. For more information see, *Private Branch Exchange (PBX) on page 18*.

1. Request the following information from your PBX provider:
 - User ID
 - Domain
 - Password
 - Authentication ID
 - Caller ID
 - Registrar
 - RTP start port
2. Go to **VoIP > SIP accounts > Create account**.
3. Enter a **Name** for the account.
4. Select **Registrar**.
5. Select a transport mode.
6. Add the account information from the PBX provider.
7. Click **Save**.
8. Set up the SIP settings the same way as for peer-to-peer. See *Set up direct SIP (P2P) on page 6* for more information.

AXIS C1410 Network Mini Speaker

Additional settings

Stop audio with DTMF

This example explains how to:

- Configure DTMF on a device.
- Set up an event to stop the audio when a DTMF command is sent to the device.

Note

SIP must be activated before you can use this action rule.

Note

For more information about events see *Set up rules and alerts on page 19*.

1. Go to **VoIP > DTMF**.
2. Select peer-to-peer or registrar account.
3. Click the pencil next to the SIP account.
4. Click **Add**.
5. In the **Name** field, enter "stop audio".
6. In the **Sequence** field, enter "1".
7. Click **Apply** and then **OK**.
8. Go to **Events > Management > Action rules** and click **Add**.
9. In the **Name** field, enter "DTMF stop audio".
10. From the list of triggers, select **Call, DTMF** and "stop".
11. From the list of actions, select **Stop audio clip** and then click **OK**.

Send an email if a speaker test fails

Several actions rules can be combined, or have a relation to each other. In this example the audio device is configured to send an email to a defined recipient when a speaker test fails. The speaker test is configured to be performed 18:00 every day.

To do that the following need to be configured:

- A recurrence
- A schedule
- A speaker test that starts a specific time
- An email recipient
- The condition of when to send the email

Note

For more information about speaker test, see *Speaker test on page 17*.

1. Set up a recurrence:
 - 1.1 Go to **Events > Management > Recurrences**.
 - 1.2 Create a recurrence that triggers once every day. Name it "speaker test recurrence".

AXIS C1410 Network Mini Speaker

Additional settings

2. Set up a schedule:
 - 2.1 Go to **Events > Management > Schedules**.
 - 2.2 Create a schedule that starts at 18:00 and ends at 18:01 (every day). Name it "speaker test schedule".
3. Set up an automated speaker test:
 - 3.1 Go to **Events > Management > Action rules** and click **Add**.
 - 3.2 Enter a name and select **Time** from the trigger list.
 - 3.3 Select **Recurrence** and select "speaker test recurrence".
 - 3.4 Select "speaker test schedule".
 - 3.5 Select **Run speaker test** as action type and click **OK**.
4. Create an email recipient:
 - 4.1 Go to **Events > Management > Recipients**, and click **Add**.
 - 4.2 Name it "speaker test recipients" and select **Email** from the **Type** list.
 - 4.3 Enter the email addresses to send emails to in the **To** field. Use commas to separate multiple addresses.
 - 4.4 Select the email provider from the **Provider** list.
 - 4.5 Enter the user ID and password for the email account.
 - 4.6 Click **Test** to send a test email.

Note

Some email providers have security filters that prevent users from receiving or viewing large attachments, from receiving scheduled emails and similar. Check the email provider's security policy to avoid delivery problems and locked email accounts.

5. Set up the condition of when to send the email:
 - 5.1 Go to **Events > Management > Action rules** and click **Add**.
 - 5.2 Enter a name and select **Speaker test** from the trigger list.
 - 5.3 Select **Test result** and select **Failed**.
 - 5.4 Select **Send notification** as action type and select "speaker test recipients" as recipient.
 - 5.5 Enter a subject and a message and click **OK**.

AXIS Audio Player

Use AXIS Audio Player to add, manage and schedule music playlists, streams and prerecorded announcements. To find AXIS Audio Player, go to the device webpage and click **Overview**.

Create a playlist

1. Click on the plus sign next to **Playlists** to add a new playlist.
2. Enter a name and click **Save**.

You can now drag and drop music files and announcements from the library to your playlist.

AXIS C1410 Network Mini Speaker

Additional settings

NOTICE

When deleting a file from the playlist it will still be in the library, but if you delete a file in the library it will be deleted both in the library and the playlist.



Add streams

1. If you have a proxy, click the settings icon in the top right corner and enter your proxy address. Supported stream formats are MP3, M3U or PLS (playlist format).
2. Select **MUSIC**.
3. Click on the plus sign next to **Streams**.
4. Write the name of the stream and the URL to your stream.
5. Click **Save**.

Create a schedule

1. Go to the **Schedule** tab.
2. Click and drag to create a box over the time slot you want to play a playlist or stream. The time and date settings on the local device are used for all scheduled activities.
3. In **New Event**:
 - Choose to play either directly from the library or to play a playlist or stream.
 - Click on the time for start or end if you want to change the time.
4. Click **Save**.

Schedule announcements

1. Go to the **Schedule** tab.
2. Click  > .
3. Choose which announcement to play and the time to play it.
4. The announcement will be marked in the schedule with .

AXIS C1410 Network Mini Speaker

Integration

Integration

Integrate audio with AXIS Camera Station

This example explains how to:

- Add an Axis network audio device to AXIS Camera Station and associate it with an Axis network camera.
- Create a button in the camera's live view in AXIS Camera Station, that makes the audio device play an audio clip.

NOTICE

This system setup is suitable for non-life critical systems, for example intruder alarms or staff and customer address. Specific guidelines and standards (local to the installation) have to be met for implementation in critical systems, such as fire evacuation.

Limitations:

- Audio sent from AXIS Camera Station to an AXIS network audio device cannot be recorded.
- An audio device must be associated with a camera in AXIS Camera Station.
- You can only associate one audio device per camera.
- There is no volume control for the audio device in AXIS Camera Station.

1. Add an AXIS network audio device to AXIS Camera Station:

1.1 In AXIS Camera Station, click  and select **Configuration**.

1.2 Go to **Devices > Add devices**.

1.3 Select the network audio device from the list and click **Add**.

1.4 Go to **Other devices** to check that the audio device has been added to the list.

2. Associate the audio device with a camera:

2.1 In AXIS Camera Station, go to **Devices > Streaming profiles** and select the camera that you want to associate the audio device with.

2.2 In the device's streaming profile, select the audio device from the **Speaker** drop-down.

2.3 Click **Apply**.

2.4 To test the association, go to the camera's **Live view** in AXIS Camera Station and click the **Speak** button. When you speak into the computer's microphone, the audio device plays the audio.

3. Prepare audio clip link:

3.1 Go to **Audio > Audio clips**.

3.2 Click the link icon for an audio clip.

3.3 Set the volume and number of times to repeat the clip.

3.4 Click the copy icon to copy the link.

4. Create a button that triggers the audio clip:

4.1 In AXIS Camera Station, go to **Configuration > Recording and events > Action rules** and click **New**.

4.2 Click **Add** to add a trigger.

AXIS C1410 Network Mini Speaker

Integration

- 4.3 In the list of triggers, select **Action button** and click **OK**.
- 4.4 If a button has been created, then select **Create new button** and click **Next**.
- 4.5 Select **Command button** and click **Next**.
- 4.6 Enter the button details, for example:
 - Button label: **Staff to till**
 - Tooltip: **Call staff to come to till**
 - Add to camera: select the camera associated with the audio device.
 - Add to map.
 - Click **OK**.

Note

You can associate the button with multiple maps or cameras.

- 4.6 Click **Next**.
- 4.7 Click **Add** to add an action.
- 4.8 In the list of actions, select **Send HTTP Notification** and click **OK**.
- 4.9 Paste the configured link from the audio device in the **URL** field.
- 4.10 Check **Authentication required** and enter the **User name** and **Password** of the audio device.
- 4.11 Click **OK**.
- 4.12 Click **Next** twice.
- 4.13 Enter a **Name** for the rule and click **Finish**.

In the camera's live view in AXIS Camera Station, there is now a button labelled **Staff to till**. When you click the button, the audio device plays the audio clip.

AXIS C1410 Network Mini Speaker

Use cases

Use cases

Set up audio devices and make live announcements



This example explains how to set up your audio device, and how to make live announcements.

Prerequisites

- The Axis audio device and Axis network camera are located on the same network.

Set up with AXIS Camera Station:



To watch this video, go to the web version of this document.

www.axis.com/products/online-manual/57927

General workflow:

- Install and add a camera and speaker to AXIS Camera Station.
- Associate the speaker with the camera.
- You can now make announcements using a button when viewing live video.

Set up with AXIS Companion:



To watch this video, go to the web version of this document.

www.axis.com/products/online-manual/57927

General workflow:

AXIS C1410 Network Mini Speaker

Use cases

- Add a speaker.
- Go to live view.
- You can now make live announcements by clicking and holding the microphone icon.

Automatically play audio when motion is detected



This example explains how to set up the audio device to play an audio clip when an Axis network camera detects motion.

Prerequisites

- The Axis audio device and Axis network camera are located on the same network.
- The motion detection application is configured and running in the camera.

General workflow

- From the device webpage, prepare a link to the audio you want to play.
- Create an action rule that triggers the audio.

Set up with AXIS Camera Station:



www.axis.com/products/online-manual/57927

Set up with Milestone:

AXIS C1410 Network Mini Speaker

Use cases



www.axis.com/products/online-manual/57927

Set up with the web client:



www.axis.com/products/online-manual/57927

Manually play audio when a camera detects motion



This example explains how to set up the audio device so that an action button appears when motion is detected. The action button can be used by the operator to play an audio clip.

Prerequisites

- The Axis audio device and Axis network camera are located on the same network.
- The motion detection application is configured and running in the camera.

General workflow

- Go to the device webpage and prepare a link to the audio you want to play.
- Return to AXIS Camera Station and create a button that will trigger the audio.

Set up with AXIS Camera Station:

AXIS C1410 Network Mini Speaker

Use cases



To watch this video, go to the web version of this document.

www.axis.com/products/online-manual/57927

AXIS C1410 Network Mini Speaker

[Learn more](#)

[Learn more](#)

Speaker test

The speaker test is a test that can be initiated from a remote location to verify that the speaker is working as intended.

The **Auto Speaker Test** must be calibrated during first time use from its mounted position at the installation site. If the speaker is moved or if its local surroundings change, for instance if a wall is built or removed, the speaker should be re-calibrated.

The speaker performs the test by playing a series of test tones that are registered by the built-in microphone. Every time you run the test, the registered values are compared with the values that were registered during the calibration.

Voice over IP (VoIP)

Voice over IP (VoIP) is a group of technologies that enables voice communication and multimedia sessions over IP networks, such as the internet. In traditional phone calls, analog signals are sent through circuit transmissions over the Public Switched Telephone Network (PSTN). In a VoIP call, analog signals are turned into digital signals to make it possible to send them in data packets across local IP networks or the internet.

In the Axis product, VoIP is enabled through the Session Initiation Protocol (SIP) and Dual-Tone Multi-Frequency (DTMF) signaling.

Session Initiation Protocol (SIP)

The Session Initiation Protocol (SIP) is used to set up, maintain and terminate VoIP calls. You can make calls between two or more parties, called SIP user agents. To make a SIP call you can use, for example, SIP phones, softphones or SIP-enabled Axis devices.

The actual audio or video is exchanged between the SIP user agents with a transport protocol, for example RTP (Real-Time Transport Protocol).

You can make calls on local networks using a peer-to-peer setup, or across networks using a PBX.

Dual-Tone Multi-Frequency (DTMF)

Dual-Tone Multi-Frequency (DTMF), also known as touch-tone, is a signaling system used by telecommunication devices such as telephone handsets, switch centers, door stations, and other communication devices.

DTMF can be used to send commands to a remote device in order to instruct the remote device to perform certain actions.

Peer-to-peer SIP (P2PSIP)

The most basic type of SIP communication takes place directly between two or more SIP user agents. This is called peer-to-peer SIP (P2PSIP). If it takes place on a local network, all that's needed are the SIP addresses of the user agents. A typical SIP address in this case would be `sip:<local-ip>`

Example

AXIS C1410 Network Mini Speaker

Learn more

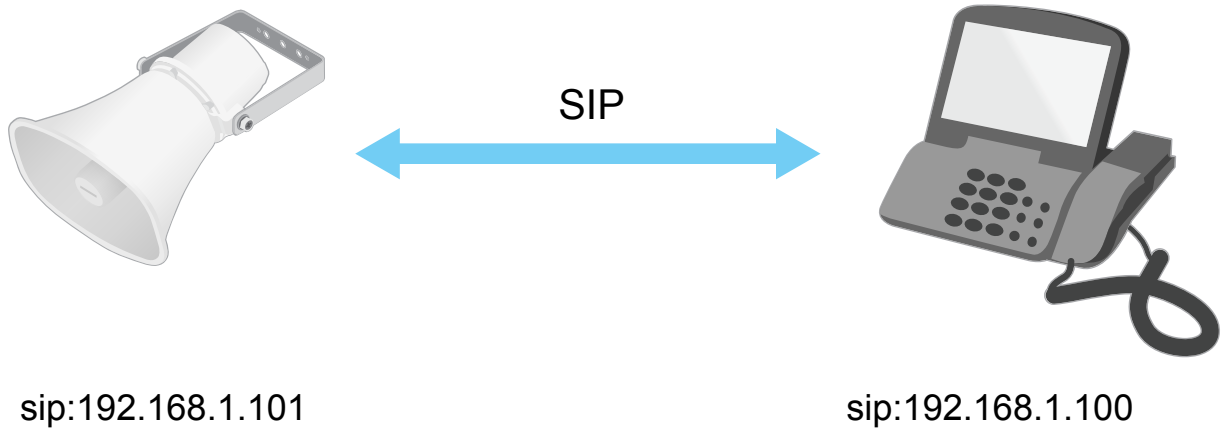

You can set up a SIP-enabled phone to call an audio device on the same network using a peer-to-peer SIP setup.

Private Branch Exchange (PBX)

When you make SIP calls outside your local IP network, a Private Branch Exchange (PBX) can act as a central hub. The main component of a PBX is a SIP server, which is also referred to as a SIP proxy or a registrar. A PBX works like a traditional switchboard, showing the client's current status and allowing for example call transfers, voicemail, and redirections.

The PBX SIP server can be set up as a local entity or offsite. It can be hosted on an intranet or by a third party provider. When you make SIP calls between networks, calls are routed through a set of PBXs, that query the location of the SIP address to be reached.

Each SIP user agent registers with the PBX, and can then reach the others by dialing the correct extension. A typical SIP address in this case would be `sip:<user>@<domain>` or `sip:<user>@<registrar-ip>`. The SIP address is independent of its IP address and the PBX makes the device accessible as long as it is registered to the PBX.

Example

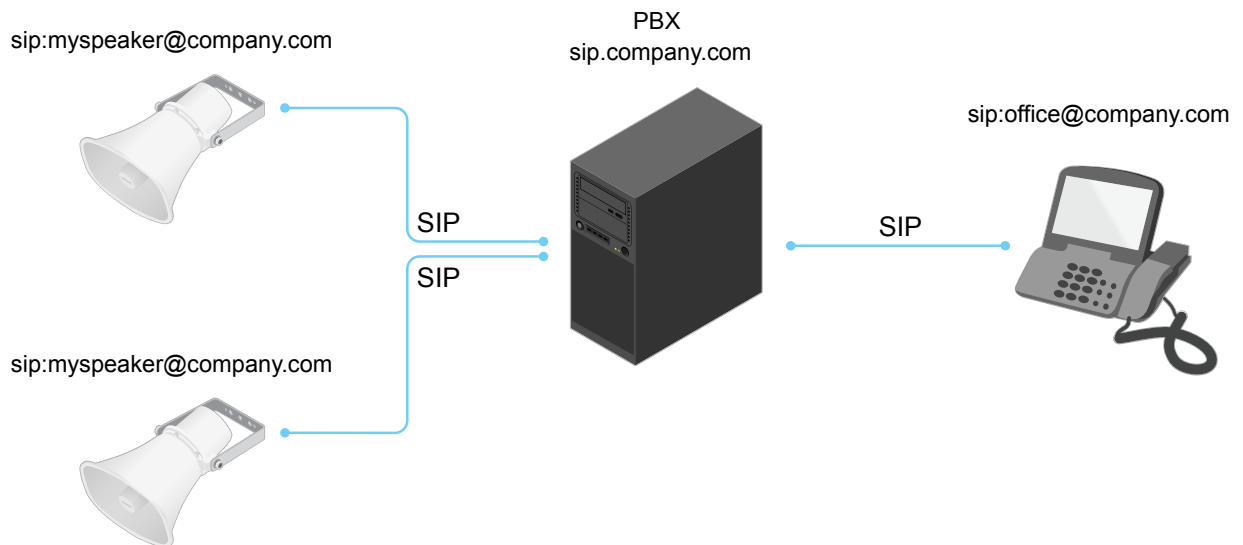

AXIS C1410 Network Mini Speaker

Learn more

NAT traversal

Use NAT (Network Address Translation) traversal when the Axis device is located on an private network (LAN) and you want to access it from outside of that network.

Note

The router must support NAT traversal and UPnP®.

Each NAT traversal protocol can be used separately or in different combinations depending on the network environment.

- **ICE** The ICE (Interactive Connectivity Establishment) protocol increases the chances of finding the most efficient path to successful communication between peer devices. If you also enable STUN and TURN, you improve the ICE protocol's chances.
- **STUN** - STUN (Session Traversal Utilities for NAT) is a client-server network protocol that lets the Axis device determine if it is located behind a NAT or firewall, and if so obtain the mapped public IP address and port number allocated for connections to remote hosts. Enter the STUN server address, for example, an IP address.
- **TURN** - TURN (Traversal Using Relays around NAT) is a protocol that lets a device behind a NAT router or firewall receive incoming data from other hosts over TCP or UDP. Enter TURN server address and the login information.

Set up rules and alerts

You can create rules to make your device perform actions when certain events occur. A rule consists of conditions and actions. The conditions can be used to trigger the actions. For example, the device can play an audio clip according to a schedule or when it receives a call, or send an email if the device changes IP address.

Applications

AXIS Camera Application Platform (ACAP) is an open platform that enables third parties to develop analytics and other applications for Axis products. To find out more about available applications, downloads, trials and licenses, go to axis.com/applications.

To find the user manuals for Axis applications, go to axis.com.

AXIS C1410 Network Mini Speaker

Troubleshooting

Troubleshooting

If you can't find what you're looking for here, try the troubleshooting section at axis.com/support.

Reset to factory default settings

Important

Reset to factory default should be used with caution. A reset to factory default resets all settings, including the IP address, to the factory default values.

To reset the product to the factory default settings:

1. Disconnect power from the product.
2. Press and hold the control button while reconnecting power. See *Product overview on page 23*.
3. Keep the control button pressed for 10 seconds until the status LED indicator turns amber for the second time.
4. Release the control button. The process is complete when the status LED indicator turns green. The product has been reset to the factory default settings. If no DHCP server is available on the network, the default IP address is 192.168.0.90
5. Use the installation and management software tools to assign an IP address, set the password, and access the product.

It is also possible to reset parameters to factory default through the web interface. Go to **Maintenance > Maintenance actions** and click **Restore** to reset to factory default values but keep the IP address, or **Default** to reset all values including the IP address.

Check the current firmware

Firmware is the software that determines the functionality of network devices. One of your first actions when you troubleshoot a problem should be to check the current firmware version. The latest version may contain a correction that fixes your particular problem.

To check the current firmware:

1. In the device's webpage, go to **Overview**.
2. Check the **Firmware version**.

Upgrade the firmware

Important

Preconfigured and customized settings are saved when the firmware is upgraded (provided that the features are available in the new firmware), although this is not guaranteed by Axis Communications AB.

Important

Make sure the device remains connected to the power source throughout the upgrade process.

Note

When you upgrade the device with the latest firmware, the device receives the latest functionality available. Always read the upgrade instructions and release notes available with each new release before you upgrade the firmware. To find the latest firmware and the release notes, go to axis.com/support/firmware

1. Download the latest firmware file to your computer, available free of charge at axis.com/support/firmware
2. Log in to the device as an administrator.

AXIS C1410 Network Mini Speaker

Troubleshooting

3. Go to **System > Maintenance > Firmware upgrade** and follow the instructions on the page. When the upgrade has finished, the device restarts automatically.

Technical issues, clues and solutions

If you can't find what you're looking for here, try the troubleshooting section at axis.com/support.

Problems upgrading the firmware

Firmware upgrade failure	If the firmware upgrade fails, the device reloads the previous firmware. The most common reason is that the wrong firmware file has been uploaded. Check that the name of the firmware file corresponds to your device and try again.
--------------------------	---

Problems setting the IP address

The device is located on a different subnet	If the IP address intended for the device and the IP address of the computer used to access the device are located on different subnets, you cannot set the IP address. Contact your network administrator to obtain an IP address.
The IP address is being used by another device	Disconnect the Axis device from the network. Run the ping command (in a Command/DOS window, type <code>ping</code> and the IP address of the device): <ul style="list-style-type: none">• If you receive: <code>Reply from <IP address>: bytes=32; time=10...</code> this means that the IP address may already be in use by another device on the network. Obtain a new IP address from the network administrator and reinstall the device.• If you receive: <code>Request timed out</code>, this means that the IP address is available for use with the Axis device. Check all cabling and reinstall the device.
Possible IP address conflict with another device on the same subnet	The static IP address in the Axis device is used before the DHCP server sets a dynamic address. This means that if the same default static IP address is also used by another device, there may be problems accessing the device.

The device cannot be accessed from a browser

Cannot log in	When HTTPS is enabled, ensure that the correct protocol (HTTP or HTTPS) is used when attempting to log in. You may need to manually type <code>http</code> or <code>https</code> in the browser's address field. If the password for the user <code>root</code> is lost, the device must be reset to the factory default settings. See <i>Reset to factory default settings on page 20</i> .
The IP address has been changed by DHCP	IP addresses obtained from a DHCP server are dynamic and may change. If the IP address has been changed, use AXIS IP Utility or AXIS Device Manager to locate the device on the network. Identify the device using its model or serial number, or by the DNS name (if the name has been configured).

The device is accessible locally but not externally

To access the device externally, we recommend using one of the following applications for Windows®:

- AXIS Camera Station: 30-day trial version free of charge, ideal for small to mid-size systems. For instructions and download, go to axis.com/vms.

Performance considerations

When setting up your system, it is important to consider how various settings and situations affect the amount of needed bandwidth (the bitrate) required.

The following factors are the most important to consider:

- Heavy network utilization due to poor infrastructure affects the bandwidth.

AXIS C1410 Network Mini Speaker

Troubleshooting

- Running multiple AXIS Camera Application Platform (ACAP) applications simultaneously may affect the the general performance.

AXIS C1410 Network Mini Speaker

Specifications

Specifications

To find the latest version of the product's datasheet, go to the product page at axis.com and locate **Support & Documentation**.

Product overview

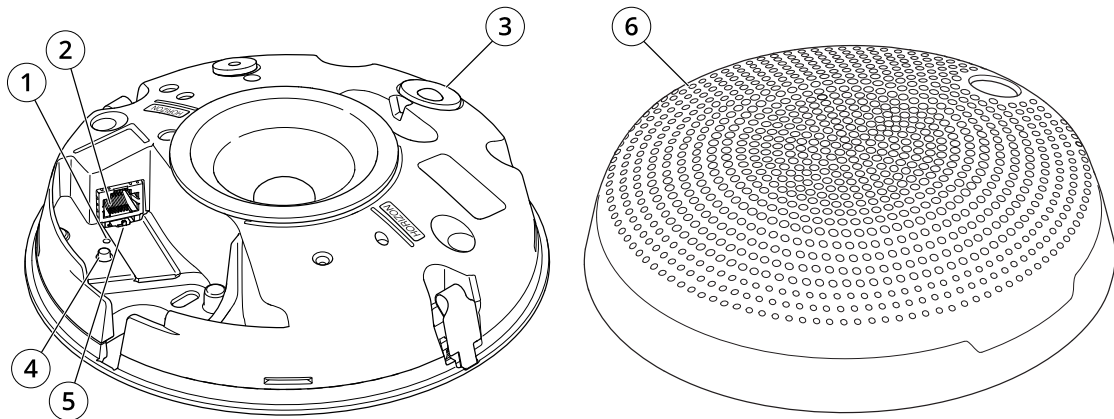

- 1 Status LED indicator
- 2 Network connector
- 3 PIR sensor
- 4 Control button
- 5 Microphone switch
- 6 Cover

LED indicators

Status LED	Indication
Unlit	Unlit for normal operation.
Green	Steady green for normal operation.
Amber	Steady during startup and when restoring settings.
Red	Slow flash for failed upgrade.

Connector and buttons

Network connector

RJ45 Ethernet connector with Power over Ethernet (PoE).

NOTICE

The product shall be connected using a shielded network cable (STP). All cables connecting the product to the network shall be intended for their specific use. Make sure that the network devices are installed in accordance with the manufacturer's instructions. For information about regulatory requirements, see the Installation Guide at www.axis.com.

AXIS C1410 Network Mini Speaker

Specifications

Control button

The control button is used for:

- Calibrating the speaker test. Press and release the control button and a test tone is played.
- Resetting the product to factory default settings. See *Reset to factory default settings on page 20*.

Microphone disable switch

For location of the microphone disable switch, see *Product overview on page 23*.

The microphone disable switch is used to mechanically turn the microphone **ON** or **OFF**. The factory default setting for this switch is **ON**.

AXIS C1410 Network Mini Speaker

API commands

API commands

VAPIX® is Axis' own open API (Application Programming Interface). You can control almost all functionality available in Axis devices through VAPIX®. To get access to the complete VAPIX® documentation, join Axis Developer Community at axis.com/developer-community

Enter the commands in a web browser, and replace <deviceIP> with the IP address or host name of your device.

Important

The API commands execute immediately. If you restore or reset your device all settings will be lost. For example action rules.

Example

Restart the device

Request

```
http://<deviceIP>/axis-cgi/restart.cgi
```

Example

Restore the device. The request returns most settings to default values, but keeps the IP number.

Request

```
http://<deviceIP>/axis-cgi/factorydefault.cgi
```

Example

Reset the device. The request returns all settings including IP number to default values.

Request

```
http://<deviceIP>/axis-cgi/hardfactorydefault.cgi
```

Example

See a list of all device parameters.

Request

```
http://<deviceIP>/axis-cgi/param.cgi?action=list
```

Example

Get a debug archive

Request

```
http://<deviceIP>/axis-cgi/debug/debug.tgz
```

Example

Get a server report

Request

```
http://<deviceIP>/axis-cgi/serverreport.cgi
```

Example

Capture a network trace of 300 seconds

Request

```
http://<deviceIP>/axis-cgi/debug/debug.tgz?cmd=pcapdump&duration=300
```

Example

Enable FTP

Request

```
http://<deviceIP>/axis-cgi/param.cgi?action=update&Network.FTP.Enabled=yes
```

Example

AXIS C1410 Network Mini Speaker

API commands

Disable FTP

Request

`http://<deviceIP>/axis-cgi/param.cgi?action=update&Network.FTP.Enabled=no`

Example

Enable SSH

Request

`http://<deviceIP>/axis-cgi/param.cgi?action=update&Network.SSH.Enabled=yes`

Example

Disable SSH

Request

`http://<deviceIP>/axis-cgi/param.cgi?action=update&Network.SSH.Enabled=no`

