

8100L and 8100S Series

Fast Ethernet Switches

- ❑ AT-8100L/8
- ❑ AT-8100L/8POE
- ❑ AT-8100L/8POE-E
- ❑ AT-8100S/24C
- ❑ AT-8100S/24
- ❑ AT-8100S/24POE
- ❑ AT-8100S/48
- ❑ AT-8100S/48POE
- ❑ AT-8100S/16F8-SC
- ❑ AT-8100S/16F8-LC
- ❑ AT-8100S/24F-LC



Stand-alone Switch Installation Guide

Copyright © 2012 Allied Telesis, Inc.

All rights reserved. No part of this publication may be reproduced without prior written permission from Allied Telesis, Inc.

Allied Telesis and the Allied Telesis logo are trademarks of Allied Telesis, Incorporated. All other product names, company names, logos or other designations mentioned herein are trademarks or registered trademarks of their respective owners.

Allied Telesis, Inc. reserves the right to make changes in specifications and other information contained in this document without prior written notice. The information provided herein is subject to change without notice. In no event shall Allied Telesis, Inc. be liable for any incidental, special, indirect, or consequential damages whatsoever, including but not limited to lost profits, arising out of or related to this manual or the information contained herein, even if Allied Telesis, Inc. has been advised of, known, or should have known, the possibility of such damages.

Electrical Safety and Emissions Standards

This product meets the following standards.

U.S. Federal Communications Commission

Radiated Energy

Note: This equipment has been tested and found to comply with the limits for a Class A digital device pursuant to Part 15 of FCC Rules. These limits are designed to provide reasonable protection against harmful interference when the equipment is operated in a commercial environment. This equipment generates, uses, and can radiate radio frequency energy and, if not installed and used in accordance with this instruction manual, may cause harmful interference to radio communications. Operation of this equipment in a residential area is likely to cause harmful interference in which case the user will be required to correct the interference at his own expense.

Note: Modifications or changes not expressly approved of by the manufacturer or the FCC, can void your right to operate this equipment.

Industry Canada

This Class A digital apparatus complies with Canadian ICES-003.

Cet appareil numérique de la classe A est conforme à la norme NMB-003 du Canada.

RFI Emissions: FCC Class A, EN55022 Class A, EN61000-3-2, EN61000-3-3, VCCI Class A, C-TICK, CE

Warning: In a domestic environment this product may cause radio interference in which case the user may be required to take adequate measures.

EMC (Immunity): EN55024

Electrical Safety: EN60950-1 (TUV), UL 60950-1 (CUL_{US})



Laser Safety

EN60825

Translated Safety Statements

Important: The  indicates that translations of the safety statement are available in the PDF document “Translated Safety Statements” posted on the Allied Telesis website at www.alliedtelesis.com.

Contents

Preface	13
Document Conventions	14
Contacting Allied Telesis	15
Chapter 1: Overview	17
Features	18
8100L and 8100S Models	18
10/100 Mbps Twisted Pair Ports	18
Fiber Optic Ports	18
Power over Ethernet	19
10/100/1000 Mbps Twisted Pair Ports	19
SFP Slots	19
Stacking Ports	20
LEDs	20
Installation Options	20
MAC Address Table	20
Management Software and Interfaces	20
Management Methods	20
Fanless Models	21
8100L Series Switches	22
Hardware Features	22
Front Panels	23
Front Panel Components	23
8100S Twisted Pair Series Switches	24
Hardware Features	24
Front Panels	25
Front Panel Components	26
8100S Fiber Optic Series Switches	27
Hardware Features	27
Front Panels	28
Fiber Optic Ports	29
Back Panels	30
Management Panels	32
Model Naming Conventions	33
10/100Base-TX Twisted Pair Ports	35
Speed	35
Duplex Mode	35
Wiring Configuration	35
Maximum Distance	36
Power Over Ethernet	36
Cable Requirements	36
Port Pinouts	36
10/100/1000Base-T Twisted Pair Ports	37
Speed	37
Duplex Mode	37
Wiring Configuration	37
Maximum Distance	38
Power Over Ethernet	38
Cable Requirements	38

Port Pinouts	38
SFP Slots	39
Power Over Ethernet	41
PoE Standards	41
Powered Device Classes	42
Power Budget	42
Port Prioritization	43
Wiring Implementation	44
Stacking Ports	45
eco-friendly Button	46
LEDs	47
10/100Base-TX Twisted Pair Port LEDs	47
10/100/1000Base-T Twisted Pair Port LEDs	48
100Base-FX Port LEDs	49
SFP Slot LED	50
Stacking Port LEDs	51
Stack ID LED	51
Console Port	53
Power Supplies	54
Power Connectors	55
Chapter 2: Beginning the Installation	57
Installation Procedures	58
Reviewing Safety Precautions	59
Choosing a Site for the Switch	63
Unpacking the Switch	64
8100L Series Switches	64
8100S Series Switches	66
AT-8100S/24C Switch	67
Chapter 3: Installing the Switch on a Table or in an Equipment Rack	69
Installing the Switch on a Table or Desktop	70
Installing the Switch in an Equipment Rack	71
Chapter 4: Cabling the Networking Ports	77
Cabling the Twisted Pair and Fiber Optic Ports	78
Twisted Pair Ports	78
Fiber Optic Ports	79
General Guidelines	79
Installing Optional SFP Transceivers	80
Chapter 5: Powering On the Switch	85
Powering On an AC Switch	86
Monitoring the Initialization Processes	87
Powering On a DC Switch	91
Setting the Stack ID Number	95
Starting a Local Management Session	95
Starting a Telnet Management Session	96
Changing the Stack ID Number	97
Starting a Management Session	99
Local Management	99
Telnet Management	99
Secure Shell Management	100
Web Browser Management	100
SNMP	101
Specifying Ports in the Command Line Interface for Stand-alone Switches	101
Chapter 6: Troubleshooting	103
Appendix A: Technical Specifications	107
Physical Specifications	107
Environmental Specifications	108
Power Specifications	109

Certifications	110
Quality and Reliability	110
RJ-45 Twisted Pair Port Pinouts.....	111
Fiber Optic Port Specifications	112
RJ-45 Style Serial Console Port Pinouts	114
Stacking Port Pinouts	114

Figures

Figure 1: Front Panels of the 8100L Series Switches.....	23
Figure 2: Networking Ports and SFP Slots on the 8100L Series Switches.....	23
Figure 3: Front Panels of the 8100S Twisted Pair Series Switches	25
Figure 4: Networking Ports and SFP Slots on the 8100S Series Switches	26
Figure 5: Front Panels of the 8100S Fiber Optic Series Switches.....	28
Figure 6: Front Panels of the 8100S Fiber Optic Series Switches (Continued).....	29
Figure 7: Back Panels of the Single Power Supply Switches.....	30
Figure 8: Back Panels of the Dual Power Supply Switches.....	31
Figure 9: 8100L Series Management Panel	32
Figure 10: 8100S Series Management Panel.....	32
Figure 11: Model Naming Conventions for the Twisted Pair 8100L and 8100S Series Switches	33
Figure 12: Model Naming Conventions of the Fiber Optic 8100S Series Switches.....	33
Figure 13: 10/100Base-TX Port LEDs	47
Figure 14: 10/100/1000Base-T Port LEDs.....	48
Figure 15: 100Base-FX Port LED	49
Figure 16: SFP Slot LEDs	50
Figure 17: Stacking Port S1 and S2 LEDs.....	51
Figure 18: Stack ID LED	52
Figure 19: Components of the 8100L Series Switches.....	65
Figure 20: Components of the 8100S Series Switches	66
Figure 21: Components of the AT-8100S/24C Switch.....	67
Figure 22: Turning the Switch Upside Down	71
Figure 23: Removing the Rubber Feet	71
Figure 24: Attaching the Brackets to Install the Switch in an Equipment Rack	72
Figure 25: Attaching the Brackets to Install the Switch in an Equipment Rack (Continued).....	73
Figure 26: Attaching the Brackets to 8100L and AT-8100S/24C Switches for Equipment Rack Installation.....	74
Figure 27: Attaching the Brackets to 8100L and AT-8100S/24C Switches for Equipment Rack Installation (Continued)....	75
Figure 28: Mounting the Switch in an Equipment Rack.....	75
Figure 29: Removing the Dust Plug from an SFP Slot	81
Figure 30: Installing an SFP Transceiver.....	81
Figure 31: Removing the Dust Cover from the SFP Module	82
Figure 32: Positioning the SFP Handle in the Upright Position	82
Figure 33: Connecting the Fiber Optic Cable to the SFP Module.....	83
Figure 34: Plugging in the AC Power Cord.....	86
Figure 35: Switch Initialization Messages.....	89
Figure 36: Switch Initialization Messages (Continued).....	90
Figure 37: DC Terminal Block.....	92
Figure 38: Stripped Wire.....	92
Figure 39: Inserting Wires into the DC Terminal Block.....	93
Figure 40: Connecting the Management Cable to the Console Port.....	95
Figure 41: AlliedWare Plus Command Line Prompt	97
Figure 42: Moving to the Global Configuration Mode with the ENABLE and CONFIGURE TERMINAL Commands	97
Figure 43: STACK Command Confirmation Prompt.....	98
Figure 44: PORT Parameter in the Command Line Interface.....	101
Figure 45: RJ-45 Socket Pin Layout (Front View)	111
Figure 46: Stacking Port Pin Layout (Front View).....	114

Tables

Table 1: Hardware Features of the 8100L Series Switches	22
Table 2: Hardware Features of the 8100S Twisted Pair Series	24
Table 3: Hardware Features of the Fiber Optic 8100S Series Switches	27
Table 4: General Specifications of the Fiber Optic Ports	29
Table 5: Model Naming Conventions for the Twisted Pair 8100L and 8100S Series Switches	33
Table 6: Model Naming Conventions for the Fiber Optic 8100S Series Switches	34
Table 7: Twisted Pair Cable Requirements for the 10/100Base-TX Ports	36
Table 8: Twisted Pair Cable for the 10/100/1000Base-T Ports	38
Table 9: Combo Ports	39
Table 10: IEEE Powered Device Classes	42
Table 11: 10/100Base-TX Port LEDs	47
Table 12: 10/10/1000Base-T Port LEDs	48
Table 13: 100Base-FX Port LED	49
Table 14: SFP Slot LED	50
Table 15: Stacking Port S1 and S2 LEDs	51
Table 16: LEDs and Management Software Initialization	88
Table 17: Product Dimensions	107
Table 18: Product Weights	107
Table 19: Ventilation Requirements	108
Table 20: Environmental Specifications for all Switches Except the AT-8100L/8POE-E Switch	108
Table 21: Environmental Specifications for the AT-8100L/8POE-E Switch	108
Table 22: Maximum Power Consumptions	109
Table 23: Input Voltages	109
Table 24: Product Certifications	110
Table 25: MTBF	110
Table 26: Pin Signals for 10 and 100 Mbps	111
Table 27: Pin Signals for 1000 Mbps	112
Table 28: Fiber Optic Port Specifications for the AT-8100S/16F8-SC Switch	112
Table 29: Fiber Optic Port Specifications for the AT-8100S/16F8-LC and AT-8100S/24F-LC Switches	113
Table 30: RJ-45 Style Serial Console Port Pin Signals	114
Table 31: Stacking Port Pin Signals	114

Preface

This guide contains the installation instructions for the 8100L and 8100S Series of Fast Ethernet switches. This manual explains how to install the units as stand-alone devices. For instructions on how to install the 8100S Series switches in a stack configuration, refer to the *Stack Installation Guide for the 8100S Series Switches*.

This preface contains the following sections:

- ❑ “Document Conventions” on page 14
- ❑ “Contacting Allied Telesis” on page 15

Document Conventions

This document uses the following conventions:

Note

Notes provide additional information.



Caution

Cautions inform you that performing or omitting a specific action may result in equipment damage or loss of data.



Warning

Warnings inform you that performing or omitting a specific action may result in bodily injury.

Contacting Allied Telesis

If you need assistance with this product, you may contact Allied Telesis technical support by going to the Support & Services section of the Allied Telesis web site at **www.alliedtelesis.com/support**. You can find links for the following services on this page:

- ❑ 24/7 Online Support — Enter our interactive support center to search for answers to your product questions in our knowledge database, to check support tickets, to learn about RMAs, and to contact Allied Telesis technical experts.
- ❑ USA and EMEA phone support — Select the phone number that best fits your location and customer type.
- ❑ Hardware warranty information — Learn about Allied Telesis warranties and register your product online.
- ❑ Replacement Services — Submit a Return Merchandise Authorization (RMA) request via our interactive support center.
- ❑ Documentation — View the most recent installation and user guides, software release notes, white papers, and data sheets for your products.
- ❑ Software Downloads — Download the latest software releases for your managed products.

For sales or corporate information, go to **www.alliedtelesis.com/purchase** and select your region.

Chapter 1

Overview

This chapter contains the following sections:

- ❑ “Features” on page 18
- ❑ “8100L Series Switches” on page 22
- ❑ “8100S Twisted Pair Series Switches” on page 24
- ❑ “8100S Fiber Optic Series Switches” on page 27
- ❑ “Back Panels” on page 30
- ❑ “Management Panels” on page 32
- ❑ “Model Naming Conventions” on page 33
- ❑ “10/100Base-TX Twisted Pair Ports” on page 35
- ❑ “10/100/1000Base-T Twisted Pair Ports” on page 37
- ❑ “SFP Slots” on page 39
- ❑ “Power Over Ethernet” on page 41
- ❑ “Stacking Ports” on page 45
- ❑ “eco-friendly Button” on page 46
- ❑ “LEDs” on page 47
- ❑ “Console Port” on page 53
- ❑ “Power Supplies” on page 54
- ❑ “Power Connectors” on page 55

Note

This guide contains instructions on how to install the 8100L and 8100S Series switches as stand-alone switches. For instructions on how to install the 8100S Series switches in a stack configuration, refer to the *Stack Installation Guide for the 8100S Series Switches*.

Features

Here is a list of the switches and their features:

8100L and 8100S Models

Here are the 8100L and 8100S Series switches:

- AT-8100L/8
- AT-8100L/8POE
- AT-8100L/8POE-E
- AT-8100S/24C
- AT-8100S/24
- AT-8100S/24POE
- AT-8100S/48
- AT-8100S/48POE
- AT-8100S/16F8-SC
- AT-8100S/16F8-LC
- AT-8100S/24F-LC

10/100 Mbps Twisted Pair Ports

Here are the basic features of the 10/100 Mbps twisted pair ports:

- 8, 24, or 48 ports per switch
- 10Base-T and 100Base-TX compliant
- IEEE 802.3u Auto-Negotiation compliant
- Auto-MDI/MDIX
- 100 meters (328 feet) maximum operating distance
- IEEE 802.3x flow control in 10/100Base-TX full-duplex operation
- IEEE 802.3x backpressure in 10/100Base-TX half-duplex operation
- Support for jumbo frames up to 10KB
- RJ-45 connectors

Fiber Optic Ports

Here are the basic features of the fiber optic ports:

- 16 or 24 ports per switch
- 100Base-FX compliant
- Duplex SC or duplex LC
- Maximum distance of 2 kilometers (1.24 miles) for the fiber optic ports on the AT-8100S/16F8-LC, AT-8100S/16F8-SC, and AT-8100S/24F-LC Switches

Power over Ethernet

Here are the basic features of Power over Ethernet (PoE):

- PoE and PoE+ supported on the 10/100Base-TX ports on the AT-8100L/8POE, AT-8100L/8POE-E, AT-8100S/24POE, and AT-8100S/48POE Switches
- Powered device classes 0 to 4
- Power budgets of 180 watts for the AT-8100L/8POE and AT-8100L/8POE-E Switches and 370 watts for the AT-8100S/24POE and AT-8100S/48POE Switches
- Port prioritization

10/100/1000 Mbps Twisted Pair Ports

Here are the basic features of the 10/100/1000 Mbps twisted pair ports:

- Two ports per switch
- 10Base-T, 100Base-TX, and 1000Base-T compliant
- IEEE 802.3u Auto-Negotiation compliant
- Auto-MDI/MDIX
- 100 meters (328 feet) maximum operating distance
- IEEE 802.3x flow control in 10/100Base-TX full-duplex mode
- IEEE 802.3x backpressure in 10/100Base-TX half-duplex mode
- IEEE 803.3z 1000Base-T flow control
- Support for jumbo frames up to 10KB
- RJ-45 connectors

SFP Slots

Here are the basic features of the SFP slots:

- Two slots per switch
- Support 100Mbps 100Base-FX or 1000Mbps 1000Base-SX/LX transceivers

Note

The SFP slots and 10/100/1000Base-TX twisted pair ports are paired together to form combo ports. For information, refer to “SFP Slots” on page 39.

Note

SFP transceivers must be purchased separately. For a list of supported transceivers, contact your Allied Telesis distributor or reseller.

Stacking Ports

Here are the basic features of the stacking ports on the 8100S Series switches:

- Two stacking ports per switch
- 10Gbps total bandwidth
- High-definition Multimedia Interface (HDMI) connectors

LEDs

Here are the port LEDs:

- Duplex mode and link/activity LEDs for the twisted pair ports
- Link/activity LEDs for the 100Base-FX fiber optic ports
- Link/activity LEDs for the SFP slots
- Link LEDs for the stacking ports
- Stack ID number LED
- eco-friendly button turns off the LEDs to conserve electricity

Installation Options

Here are the installation options for stand-alone switches:

- 19-inch equipment rack
- Desk or tabletop

MAC Address Table

Here are the basic features of the MAC address tables of the switches:

- Storage capacity of 16,000 MAC address entries
- Automatic learning and aging

Management Software and Interfaces

Here are the management software and management interfaces:

- AlliedWare Plus Management Software
- Command line interface
- Web browser interface

Management Methods

Here are the methods for managing the switches:

- Local management through the Console port
- Remote Telnet and Secure Shell management
- Remote HTTP and HTTPS web browser management
- SNMPv1, v2c, and v3

Fanless Models Here are the 8100L and 8100S Series switches that do not have fans:

- AT-8100L/8 Switch
- AT-8100S/24 Switch
- AT-8100S/24C Switch
- AT-8100S/48 Switch

8100L Series Switches

The three models in the 8100L Series are listed here:

- ❑ AT-8100L/8
- ❑ AT-8100L/8POE
- ❑ AT-8100L/8POE-E

Hardware Features Table 1 lists the hardware features of the 8100L Series switches.

Table 1. Hardware Features of the 8100L Series Switches

Feature	8	8POE	8POE-E
Number of 10/100Base-TX Ports	8	8	8
Number of 10/100/1000Base-T Ports	2	2	2
Number of SFP Slots for 100Mbps 100Base-FX or 1000Mbps 1000Base-SX/LX Transceivers ¹	2	2	2
Stacking Ports	No	No	No
Power over Ethernet	No	Yes	Yes
Power over Ethernet Budget (Watts)	-	180	180
Powered Device Classes	-	0 to 4	0 to 4
Number of Power Supplies	1	1	1
Power Supply Type	AC	AC	AC
Console Management Port	Yes	Yes	Yes
Ventilation Fan	No	Yes	Yes

1. The SFP transceiver slots and 10/100/1000Base-T ports are paired together to form combo ports. Refer to "SFP Slots" on page 39 for background information.

Note

The AT-8100L/8POE-E switch has an extended operating temperature range, which is signified by the "-E" in the model name. In all other respects, it is identical to the AT-8100L/8POE switch. The operating temperature ranges of the models are listed in "Environmental Specifications" on page 108.

Front Panels The front panels of the 8100L Series switches are shown in Figure 1.

AT-8100L/8



AT-8100L/8POE

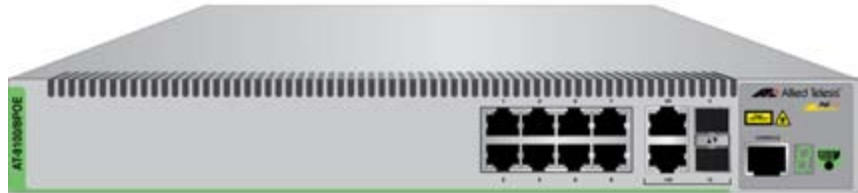

AT-8100L/8POE-E



Figure 1. Front Panels of the 8100L Series Switches

Front Panel Components

Figure 2 identifies the Fast and Gigabit Ethernet networking ports and the SFP slots on the 8100L Series switches.

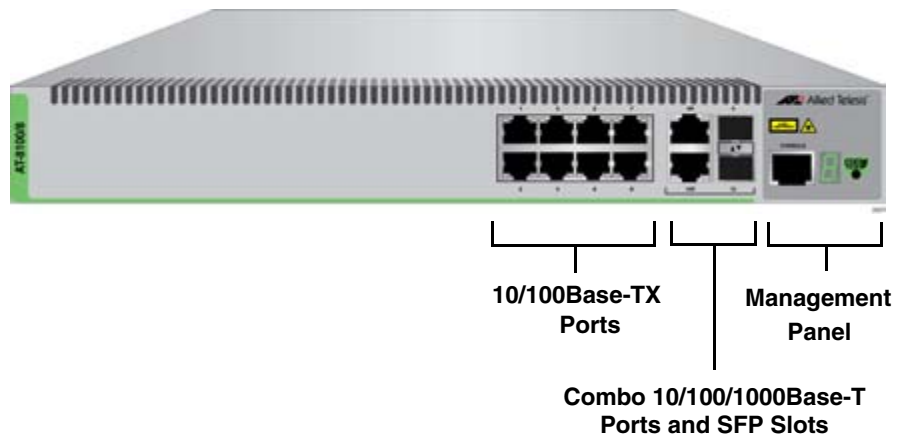

Figure 2. Networking Ports and SFP Slots on the 8100L Series Switches

8100S Twisted Pair Series Switches

The five twisted pair models in the 8100S Series are listed here:

- ❑ AT-8100S/24C
- ❑ AT-8100S/24
- ❑ AT-8100S/24POE
- ❑ AT-8100S/48
- ❑ AT-8100S/48POE

For information on the fiber optic models, refer to “8100S Fiber Optic Series Switches” on page 27.

Hardware Features Table 2 lists the hardware features of the twisted pair models of the 8100S Series switches.

Table 2. Hardware Features of the 8100S Twisted Pair Series

Feature	24C	24	24POE	48	48POE
Number of 10/100Base-TX Ports	24	24	24	48	48
Number of 10/100/1000Base-T Ports	2	2	2	2	2
Number of SFP Slots for 100Mbps 100Base-FX or 1000Mbps 1000Base-SX/LX Transceivers ¹	2	2	2	2	2
Stacking Ports	Yes	Yes	Yes	Yes	Yes
Power over Ethernet	No	No	Yes	No	Yes
Power over Ethernet Budget (Watts)	-	-	370	-	370
Powered Device Classes	-	-	0 to 4	-	0 to 4
Number of Power Supplies	1	2	2	2	2
Power Supply Type	AC	AC or DC	AC	AC	AC
Console Management Port	Yes	Yes	Yes	Yes	Yes
Ventilation Fan	No	No	Yes	No	Yes

1. The SFP transceiver slots are paired with the 10/100/1000Base-T ports to form combo ports. Refer to “SFP Slots” on page 39 for background information.

Front Panels The front panels of the 8100S Series switches are shown in Figure 3.

AT-8100S/24C



AT-8100S/24

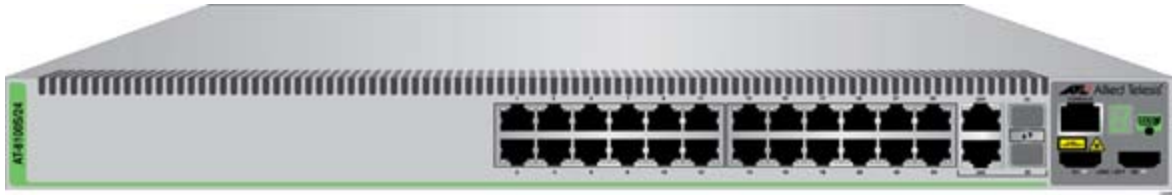

AT-8100S/24POE

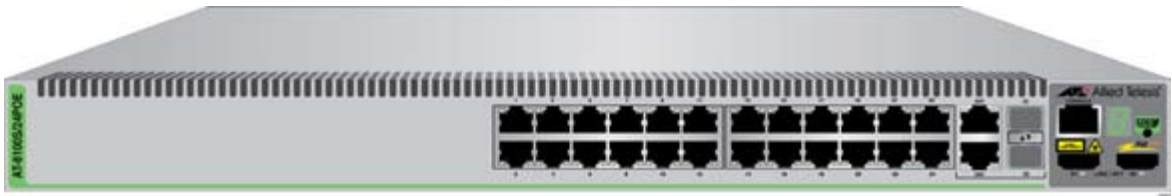

AT-8100S/48

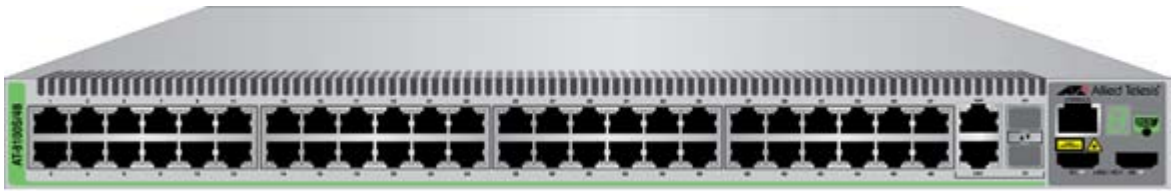

AT-8100S/48POE



Figure 3. Front Panels of the 8100S Twisted Pair Series Switches

Front Panel Components

Figure 4 identifies the Fast and Gigabit Ethernet networking ports and the SFP slots on the 8100S Series switches.

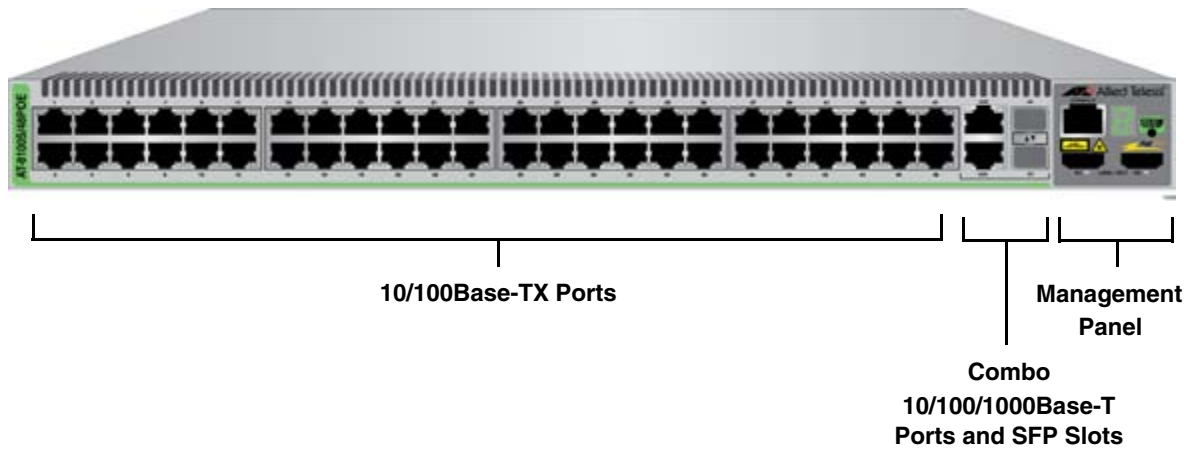

Figure 4. Networking Ports and SFP Slots on the 8100S Series Switches

8100S Fiber Optic Series Switches

The three fiber optic models in the 8100S Series are listed here:

- ❑ AT-8100S/16F8-SC
- ❑ AT-8100S/16F8-LC
- ❑ AT-8100S/24F-LC

Hardware Features Table 3 lists the hardware features of the fiber optic 8100S Series switches.

Table 3. Hardware Features of the Fiber Optic 8100S Series Switches

Feature	16F8-SC	16F8-LC	24F-LC
Number of 100Base-FX Fiber Optic Ports	16	16	24
Connectors	Duplex SC	Duplex LC	Duplex LC
Maximum Distance per Port	2 kilometers (1.24 miles)	2 kilometers (1.24 miles)	2 kilometers (1.24 miles)
Number of 10/100Base-TX Ports	8	8	0
Number of 10/100/1000Base-T Ports	2	2	2
Number of SFP Slots for 100Mbps 100Base-FX or 1000Mbps 1000Base-SX/LX Transceivers ¹	2	2	2
Stacking Ports	Yes	Yes	Yes
Power over Ethernet	No	No	No
Number of Power Supplies	2	2	2
Power Supply Type	AC	AC	AC
Console Management Port	Yes	Yes	Yes
Ventilation Fan	Yes	Yes	Yes

1. The SFP transceiver slots and the 10/100/1000Base-T ports are paired together to form combo ports, as explained in "SFP Slots" on page 39.

Front Panels The front panels of the fiber optic switches are shown in Figure 5 and Figure 6 on page 29.

AT-8100S/16F8-SC

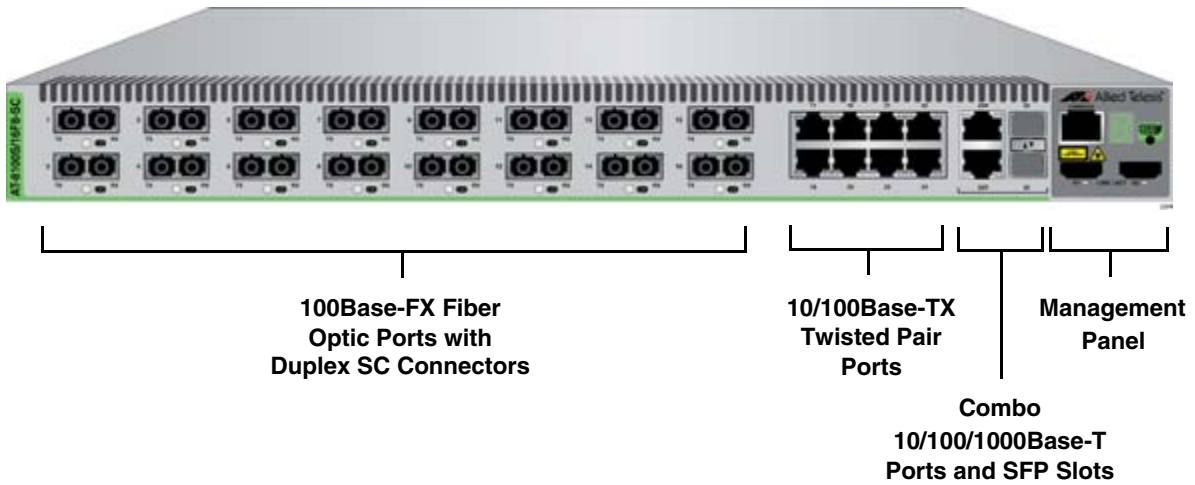

AT-8100S/16F8-LC

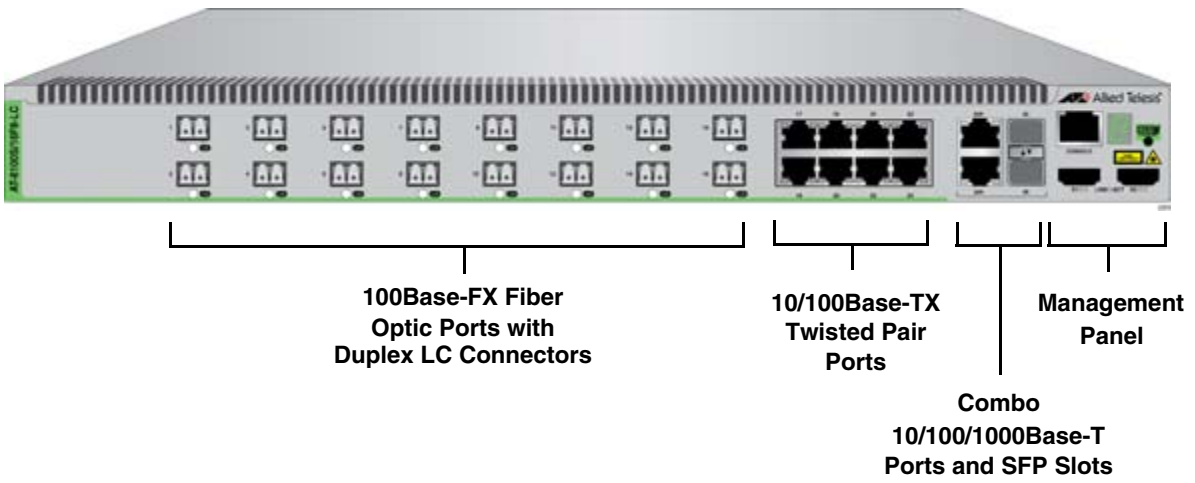

Figure 5. Front Panels of the 8100S Fiber Optic Series Switches

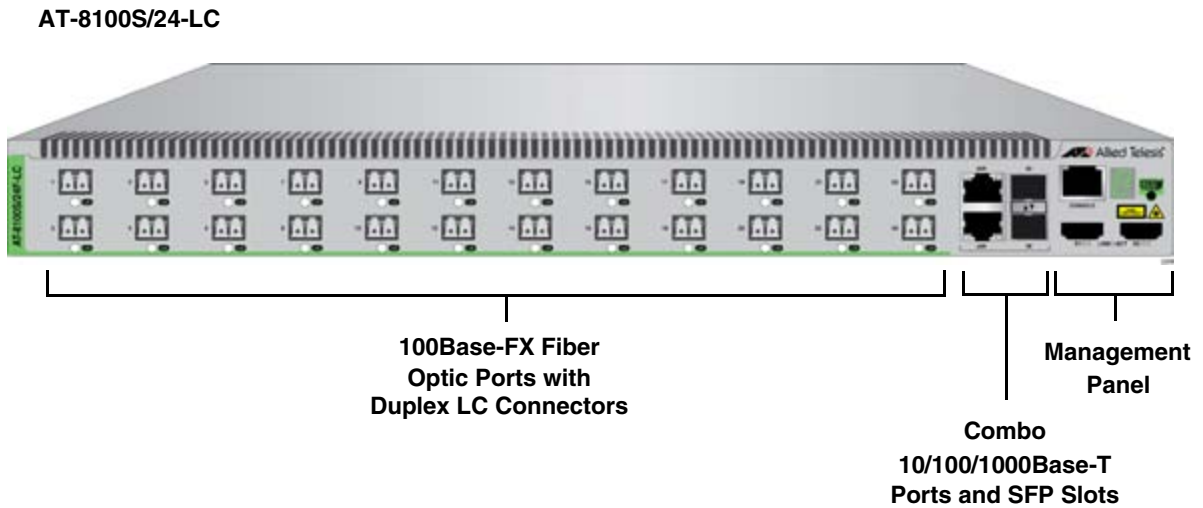

Figure 6. Front Panels of the 8100S Fiber Optic Series Switches (Continued)

Fiber Optic Ports Table 4 lists the general specifications of the fiber optic ports on the fiber optic switches.

Table 4. General Specifications of the Fiber Optic Ports

Feature	16F8-SC	16F8-LC	24F-LC
Number of Fiber Optic Ports	16	16	24
Connector	Duplex SC	Duplex LC	Duplex LC
Wavelength	Transmit and receive: 1310 nm	Transmit and receive: 1310 nm	Transmit and receive: 1310 nm
Standard	100Base-FX	100Base-FX	100Base-FX
Speed	100 Mbps	100 Mbps	100 Mbps
Maximum Distance	2 kilometers (1.24 miles)	2 kilometers (1.24 miles)	2 kilometers (1.24 miles)
Fiber Optic Cable	50/125 or 62.5/125 μm (core/cladding) multimode fiber optic cable	50/125 or 62.5/125 μm multimode fiber optic cable	50/125 or 62.5/125 μm multimode fiber optic cable

Back Panels

Figure 7 shows the back panels of the single power supply switches.

AT-8100L/8 and AT-8100S/24C Switches

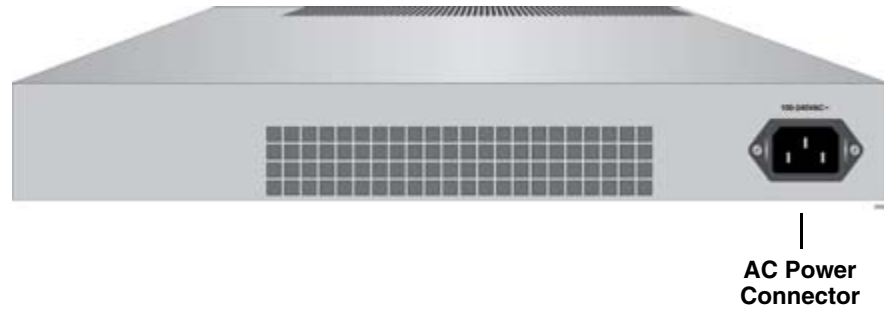

AT-8100L/8POESwitch

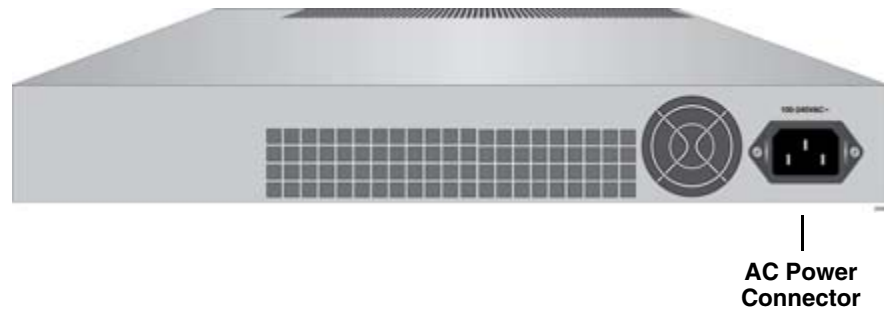

Figure 7. Back Panels of the Single Power Supply Switches

Figure 8 shows the back panels of the dual power supply switches.

Dual AC Power Supply Models



Dual DC Power Supply Models



Figure 8. Back Panels of the Dual Power Supply Switches

Management Panels

Figure 9 identifies the components in the management panel on the 8100L Series switches.

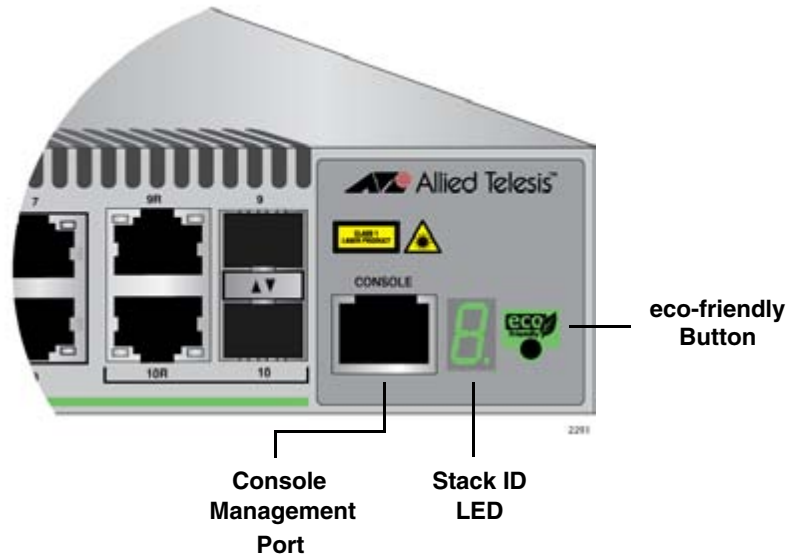

Figure 9. 8100L Series Management Panel

Figure 10 identifies the components in the management panel on the 8100S Series switches.

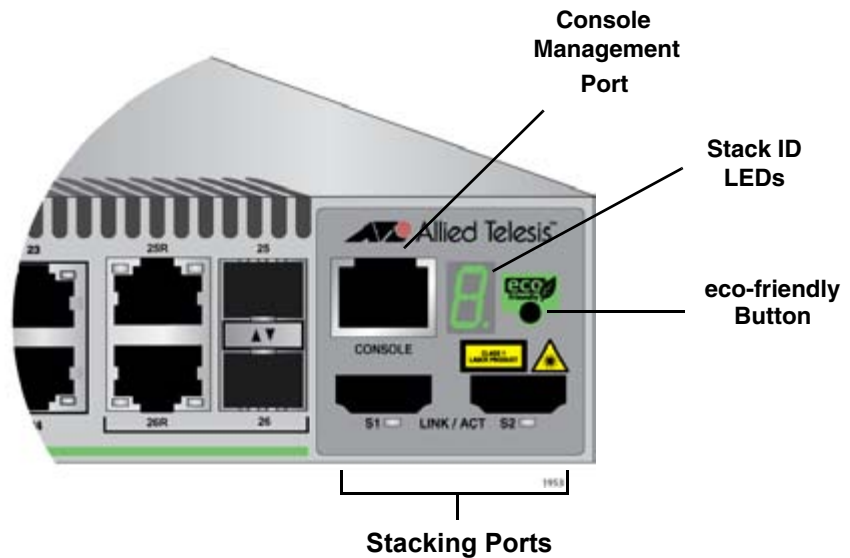

Figure 10. 8100S Series Management Panel

Model Naming Conventions

The hardware features of the switches are represented by the letters and numbers in the model names. The conventions for the twisted pair 8100L and 8100S Series switches are identified in Figure 11.

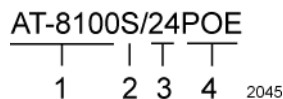

Figure 11. Model Naming Conventions for the Twisted Pair 8100L and 8100S Series Switches

The conventions are defined in Table 5.

Table 5. Model Naming Conventions for the Twisted Pair 8100L and 8100S Series Switches

Convention	Definition
1	This is the product name.
2	The letter “S” indicates that the model is stackable. The letter “L” indicates that the model is not stackable.
3	This is the number of 10/100Base-TX ports.
4	The letters “POE” indicate support for Power over Ethernet.

The letter “C” in the AT-8100S/24C model name denotes that the unit, which has just one power supply, has a smaller, more compact size than the other 8100S Series switches.

The “-E” in the AT-8100L/8POE-E model name indicates that the switch has an extended operating temperature range. For details, refer to “Environmental Specifications” on page 108.

The model naming conventions for the fiber optic 8100S Series switches are identified in Figure 12.

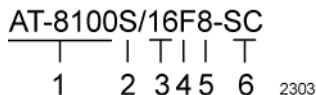

Figure 12. Model Naming Conventions of the Fiber Optic 8100S Series Switches

The conventions are defined in Table 6.

Table 6. Model Naming Conventions for the Fiber Optic 8100S Series Switches

Convention	Definition
1	This is the product name.
2	The letter “S” indicates that the model is stackable.
3	This is the number of 100Base-FX fiber optic ports.
4	The letter “F” signifies fiber optic.
5	This is the number of 10/100Base-TX ports. The fiber optic switches that have 10/100Base-TX ports are the AT-8100S/16F8-SC and AT-8100S/16F8-LC Switches.
6	<p>This identifies the type of fiber optic connector. The connectors are listed here:</p> <ul style="list-style-type: none"> <li data-bbox="776 890 1029 919">❑ SC - Duplex SC <li data-bbox="776 936 1029 966">❑ LC - Duplex LC

10/100Base-TX Twisted Pair Ports

The switches have 8, 24, or 48 10/100Base-TX ports.

Speed The ports can operate at either 10 or 100 Mbps. The speeds may be set manually using the management software or automatically with Auto-Negotiation (IEEE 802.3u), the default setting.

Duplex Mode The twisted pair ports can operate in either half- or full-duplex mode. The duplex mode determines the manner in which a port transmits data. A port set to half-duplex can either transmit or receive data at one time, while a port operating in full-duplex can transmit and receive data at the same time. The best network performance is achieved with the full-duplex setting, but not all network equipment is designed to support that duplex mode.

The duplex modes, like port speeds, may be set manually using the management software or automatically with Auto-Negotiation (IEEE 802.3u), the default setting.

The speed and duplex mode settings of a port may be set independently of each other. For example, a port may be configured such that its speed is set manually while its duplex mode is established through Auto-Negotiation.

Note

A switch port that is connected to a network device that does not support Auto-Negotiation and has a fixed duplex mode of full-duplex should not set its duplex mode with Auto-Negotiation. A duplex-mode mismatch in which a switch port and a network device operate at different duplex modes, may occur. The duplex modes of switch ports that are connected to network devices that do not support Auto-Negotiation should be set manually through the management software.

Wiring Configuration The wiring configuration of a port can be MDI or MDI-X. The wiring configurations of a switch port and a network device connected with straight-through twisted pair cabling have to be opposite, such that one device is using MDI and the other MDI-X. For instance, a switch port has to be set to MDI-X if it is connected to a network device set to MDI.

You may set the wiring configurations of the ports manually or let the switch configure them automatically with auto-MDI/MDI-X (IEEE 802.3ab-compliant). This feature enables the switch to negotiate with network devices to establish the proper settings, so that the ports on the devices are using different wiring configurations.

Maximum Distance The ports have a maximum operating distance of 100 meters (328 feet).

Power Over Ethernet The 10/100Base-TX ports on the AT-8100S/24POE and AT-8100S/48POE Switches support Power over Ethernet (PoE), which is a standard whereby DC power is provided by the switch to network devices over the network twisted pair cables. The switches support PoE (IEEE 802.3af) and PoE+ (IEEE 802.3at). For background information, refer to “Power Over Ethernet” on page 41.

Cable Requirements The cable requirements of the ports are given in Table 7.

Table 7. Twisted Pair Cable Requirements for the 10/100Base-TX Ports

Cable Type	10Mbps			100Mbps		
	Non-PoE	PoE	PoE+	Non-PoE	PoE	PoE+
Standard TIA/EIA 568-B-compliant Category 3 shielded or unshielded cabling with 100 ohm impedance and a frequency of 16 MHz.	Yes	No	No	Yes	No	No
Standard TIA/EIA 568-A-compliant Category 5 shielded or unshielded cabling with 100 ohm impedance and a frequency of 100 MHz.	Yes	Yes	No	Yes	Yes	No
Standard TIA/EIA 568-B-compliant Enhanced Category 5 (Cat 5e) shielded or unshielded cabling with 100 ohm impedance and a frequency of 100 MHz.	Yes	Yes	Yes	Yes	Yes	Yes
Standard TIA/EIA 568-B-compliant Category 6 or 6a shielded cabling.	Yes	Yes	Yes	Yes	Yes	Yes

Port Pinouts Refer to Table 26 on page 111 for the port pinouts of the 10/100Base-TX twisted pair ports.

10/100/1000Base-T Twisted Pair Ports

The switches have two 10/100/1000Base-T ports. These ports are paired with SFP slots to form combo ports.

Speed The ports can operate at 10, 100, or 1000 Mbps. The speeds may be set manually using the management software or automatically with Auto-Negotiation (IEEE 802.3u), the default setting.

Note

The ports must be set to Auto-Negotiation to function at 1000 Mbps. They are not compatible with devices that are not IEEE 802.3u compliant.

Duplex Mode The twisted pair ports can operate in either half- or full-duplex mode. The duplex modes, like port speeds, may be set manually using the management software or automatically with Auto-Negotiation (IEEE 802.3u), the default setting.

The speed and duplex mode settings of a port may be set independently of each other. For example, a port may be configured such that its speed is set manually while its duplex mode is established through Auto-Negotiation.

Note

A switch port that is connected to a network device that does not support Auto-Negotiation and has a fixed duplex mode of full-duplex should not set its duplex mode with Auto-Negotiation. A duplex-mode mismatch in which a switch port and a network device operate at different duplex modes, may occur. The duplex modes of switch ports that are connected to network devices that do not support Auto-Negotiation should be set manually through the management software.

Wiring Configuration The wiring configuration of a port operating at 10 or 100 Mbps can be MDI or MDI-X. The wiring configurations of a switch port and a network device connected with straight-through twisted pair cabling have to be opposite, such that one device is using MDI and the other MDI-X. For instance, a switch port has to be set to MDI-X if it is connected to a network device set to MDI.

You may set the wiring configurations of the ports manually or let the switch configure them automatically with auto-MDI/MDI-X (IEEE 802.3ab-compliant). This feature enables the switch to automatically negotiate with network devices to establish the proper settings.

The MDI and MDI-X settings do not apply when the ports are operating at 1000 Mbps.

Maximum Distance

The ports have a maximum operating distance of 100 meters (328 feet).

Power Over Ethernet

The 10/100/1000Base-T ports on the AT-8100L/8POE, AT-8100S/24POE and AT-8100S/48POE Switches do not support PoE.

Cable Requirements

The cable requirements of the ports are given in Table 8.

Table 8. Twisted Pair Cable for the 10/100/1000Base-T Ports

Cable Type	10Mbps	100Mbps	1000Mbps
Standard TIA/EIA 568-B-compliant Category 3 shielded or unshielded cabling with 100 ohm impedance and a frequency of 16 MHz.	Yes	Yes	No
Standard TIA/EIA 568-A-compliant Category 5 or TIA/EIA 568-B-compliant Enhanced Category 5 (Cat 5e) shielded or unshielded cabling with 100 ohm impedance and a frequency of 100 MHz.	Yes	Yes	Yes
Standard TIA/EIA 568-B-compliant Category 6 or 6a shielded cabling.	Yes	Yes	Yes

Port Pinouts

Refer to Table 26 on page 111 and Table 27 on page 112 for the port pinouts of the 10/100/1000Base-T twisted pair ports.

SFP Slots

The switches have two slots for 100Mbps 100Base-FX or 1000Mbps 1000Base-SX/LX fiber optic transceivers. The transceivers can be used to connect the switches to other network devices over large distances, build a high-speed backbone network between network devices, or connect high-speed devices, such as servers, to your network.

The switches support a variety of short and long distance, 100 and 1000 Mbps fiber optic SFP modules. For a list of supported SFP modules, contact your Allied Telesis representative or visit our web site.

The two SFP slots are paired with the two 10/100/1000Base-T ports. The combo ports are listed in Table 9.

Table 9. Combo Ports

Model	10/100/1000 Base-T Port	SFP Slot
AT-8100L/8, AT-8100L/8POE, and AT-8100L/8POE-E	9R	9
	10R	10
AT-8100S/24C, AT-8100S/24, AT-8100S/24POE, AT-8100S/16F8-LC, AT-8100S/16F8-SC, and AT-8100S/24F-LC	25R	25
	26R	26
AT-8100S/48 and AT-8100S/48POE	49R	49
	50R	50

The rules for using the combo ports are listed here:

- Only one port in a combo pair is active at a time.
- The twisted pair port is the default active port.
- The SFP slot becomes active when an SFP transceiver establishes a link to another network node.
- The twisted pair port of a combo pair remains deactivated so long as the SFP transceiver has a link to another network device.
- The switch automatically reactivates the twisted pair port if the companion SFP module loses its network link.
- The twisted pair port and SFP module of a combo port share the same settings, such as VLAN assignments, access control lists, and spanning tree.

- ❑ Port speed is an exception to the shared settings of the twisted pair port and SFP slot of a combo port. If you disable Auto-Negotiation on the twisted pair port and set the speed and duplex mode manually, the switch reactivates it when an SFP module establishes a link with an end node.

Power Over Ethernet

The AT-8100L/8POE, AT-8100L/8POE-E, AT-8100S/24POE, and AT-8100S/48POE Switches feature Power over Ethernet (PoE) on the 10/100Base-TX ports. PoE is used to supply power to network devices over the same twisted pair cables that carry the network traffic.

The main advantage of PoE is that it makes it easier to install a network. The placement of network devices is often limited by whether there are power sources nearby. This often limits equipment placement or requires the added time and cost of having additional electrical sources installed. But with PoE, you can install PoE-compatible devices wherever they are needed without having to worry about whether there are power sources nearby.

A device that provides PoE to other network devices is referred to as *power sourcing equipment* (PSE). The AT-8100L/8POE, AT-8100L/8POE-E, AT-8100S/24POE, and AT-8100S/48POE Switches act as PSE units by adding DC power to the network cable, thus functioning as a central power source for other network devices.

Devices that receive their power from a PSE are called *powered devices* (PD). Examples include wireless access points, IP telephones, webcams, and even other Ethernet switches.

The switch automatically determines whether or not a device connected to a port is a powered device. Ports that are connected to network nodes that are not powered devices (that is, devices that receive their power from another power source) function as regular Ethernet ports, without PoE. The PoE feature remains activated on the ports but no power is delivered to the devices.

PoE Standards

The AT-8100L/8POE, AT-8100L/8POE-E, AT-8100S/24POE, and AT-8100S/48POE Switches support these PoE standards:

- ❑ PoE (IEEE 802.3af): This standard provides up to 15.4 watts at the switch port to support powered devices that require up to 12.95 watts.
- ❑ PoE+ (IEEE 802.3at): This standard provides up to 30.0 watts at the switch port to support powered devices that require up to 25.5 watts.

Powered Device Classes

Powered devices are grouped into the five classes listed in Table 10 on page 42. The classes are based on the amount of power the devices require. The switches support all five classes.

Table 10. IEEE Powered Device Classes

Class	Maximum Power Output from a Switch Port	PD Power Range
0	15.4W	0.44W to 12.95W
1	4.0W	0.44W to 3.84W
2	7.0W	3.84W to 6.49W
3	15.4W	6.49W to 12.95W
4	30.0W	12.95W to 25.5W

Power Budget

The AT-8100L/8POE and AT-8100L/8POE-E Switches have a power budget of 180 watts. The AT-8100S/24POE and AT-8100S/48POE Switches have a power budget of 370 watts. These are the maximum amounts of power the switches can provide at one time to the powered devices.

The AT-8100S/24POE and AT-8100S/48POE Switches have two power supplies. Each power supply is responsible for providing 185 watts, or half, of the power budget. Both power supplies must be connected to AC power sources for the switch to provide the full 370 watts. The power budget is reduced to 185 watts if only one power supply is connected to a power source.

The power requirements of the PoE devices determine the maximum number of devices the switch can support at one time. So long as the total power requirements of the powered devices is less than the power budget of the switch, the switch can supply power to all of the devices. If the total power requirements exceed the power budget, the switch denies power to one or more ports using a mechanism referred to as port prioritization.

To determine whether the power requirements of the PoE devices you plan to connect to the switch exceed its power budget, refer to their documentation for their power requirements and add the requirements together. The switch should be able to power all of the devices simultaneously as long as the total is below its power budget. If the total exceeds the available power budget, you should consider reducing the number of PoE devices so that all of the devices receive power. Otherwise, the switch powers a subset of the devices, based on port prioritization.

The switch can handle different power requirements on different ports. This enables you to connect different classes of PoE equipment to the ports on the switch.

Port Prioritization

If the power requirements of the powered devices exceed the switch's power budget, the switch denies power to some ports based on a system called port prioritization. You may use this mechanism to ensure that powered devices critical to the operations of your network are given preferential treatment by the switch in the distribution of power should the demands of the devices exceed the available capacity.

There are three priority levels:

- Critical
- High
- Low

Ports set to the Critical level, the highest priority level, are guaranteed power before any of the ports assigned to the other two priority levels. Ports assigned to the other priority levels receive power only if all the Critical ports are receiving power. Ports that are connected to your most critical powered devices should be assigned to this level. If there is not enough power to support all the ports set to the Critical priority level, power is provided to the ports based on port number, in ascending order.

The High level is the second highest level. Ports set to this level receive power only if all the ports set to the Critical level are already receiving power. If there is not enough power to support all of the ports set to the High priority level, power is provided to the ports based on port number, in ascending order.

The lowest priority level is Low. This is the default setting. Ports set to this level only receive power if all of the ports assigned to the other two levels are already receiving power. As with the other levels, if there is not enough power to support all of the ports set to the Low priority level, power is provided to the ports based on port number, in ascending order.

Power allocation is dynamic. Ports supplying power to powered devices may cease power transmission if the switch's power budget is at maximum usage and new powered devices, connected to ports with higher priorities, become active.

You can use port prioritization on dual power supply PoE switches to protect your important networking devices from loss of power should one of the power supplies fail or lose power. By limiting the power requirements of the critical devices connected to a switch to less than 185 watts, the PoE power provided by a single power supply, a switch will have sufficient power to support the critical devices even if it has only one functional power supply.

Wiring Implementation

The IEEE 802.3af standard defines two methods by which a PSE, such as the switch, can transmit DC power over twisted pair cables to PDs. These methods, known as modes A and B, identify the wire strands the switch should use when sending DC power to a PD.

Twisted pair cabling typically consists of eight strands. With 10Base-T and 100Base-TX devices, the strands connected to pins 1, 2, 3, and 6 on the RJ-45 connectors carry the network traffic while strands connected to pins 4, 5, 7, and 8 are unused. With 1000Base-T devices, all eight strands are used to carry network data.

It takes four strands to deliver DC power to a PD. With Mode A, the power is delivered on pins 1, 2, 3, and 6. These are the same pins in 10Base-T and 100Base-TX devices that carry the network data. With mode B, the power is provided over the spare strands.

The ports on the AT-8100S/24POE and AT-8100S/48POE Switches deliver the power using pins 4, 5, 7, and 8, which corresponds to mode B in the IEEE 802.3af standard.

Powered devices that comply with the IEEE 802.3af standard are required to support both power delivery methods. Legacy devices that do not comply with the standard will work with the switch if they are powered on pins 4, 5, 7, and 8.

Stacking Ports

The 8100S Series switches may be used as stand-alone units or as part of a virtual stack in which the units are interconnected via the stacking ports on the front panels. Compared to stand-alone switches, which function as independent units, the switches of a virtual stack synchronize their actions to form a single, logical unit so that the switching operations, like spanning tree protocols, virtual LANs, and static port trunks, are able to span across all of the units and ports.

The two principal advantages of stacks are:

- ❑ You can manage multiple units simultaneously, which can simplify network management.
- ❑ You have more flexibility in how you configure some of the features. For instance, a static port trunk on a stand-alone switch has to consist of ports from the same switch. In contrast, a static trunk on a stack may consist of ports from different switches in the same stack.

For instructions on how to install a virtual stack of 8100S Series switches, refer to the *Stack Installation Guide for the 8100S Series Switches*.

Note

The 8100L Series switches do not support stacking.

eco-friendly Button

You may turn off the port LEDs to conserve electricity when you are not monitoring the switch. The LEDs may be toggled with the eco-friendly button on the front panel of the switch or the ECOFRIENDLY LED and NO ECOFRIENDLY LED commands in the Global Configuration mode of the command line interface.

Toggling the LEDs on and off does not interfere with the network operations of the device. The Stack ID LED is always on.

Note

When checking or troubleshooting the network connections to the ports on the switch, you should always check to be sure that the LEDs are on by either pressing the eco-friendly button or issuing the ECOFRIENDLY LED and NO ECOFRIENDLY LED commands in the Global Configuration mode of the command line interface.

LEDs

Here are descriptions of the switch's LEDs.

10/100Base-TX Twisted Pair Port LEDs

The 10/100Base-TX twisted pair ports have link/activity and duplex mode LEDs.

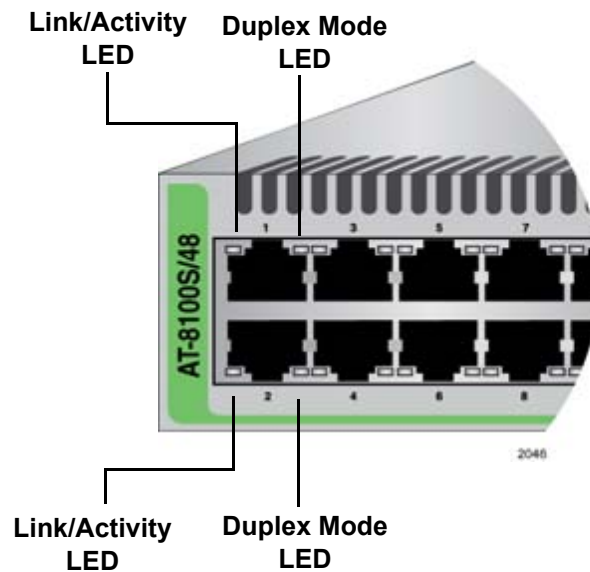

Figure 13. 10/100Base-TX Port LEDs

The LEDs are described in Table 11.

Table 11. 10/100Base-TX Port LEDs

LED	State	Description
Link/Activity	Off	The port has not established a link to an end node.
	Solid green	The port has established a link to an end node.
	Flashing green	The port is receiving or transmitting packets.
Duplex Mode	Off	The port is operating in half-duplex mode.
	Solid green	The port is operating in full-duplex mode.

Here are the LED guidelines:

- ❑ The LEDs do not display port speed. That information may be displayed using the management software.
- ❑ The LEDs do not display PoE information on the AT-8100S/24POE and AT-8100S/48POE Switches. That information may be viewed using the management software.
- ❑ If the port LEDs are off, the switch may be operating in the low power mode. To toggle on the LEDs, use the eco-friendly button.

**10/100/1000Base-T
Twisted Pair Port
LEDs**

The twisted pair ports in the combo ports have link/activity and duplex mode LEDs, just like the 10/100Base-TX ports.

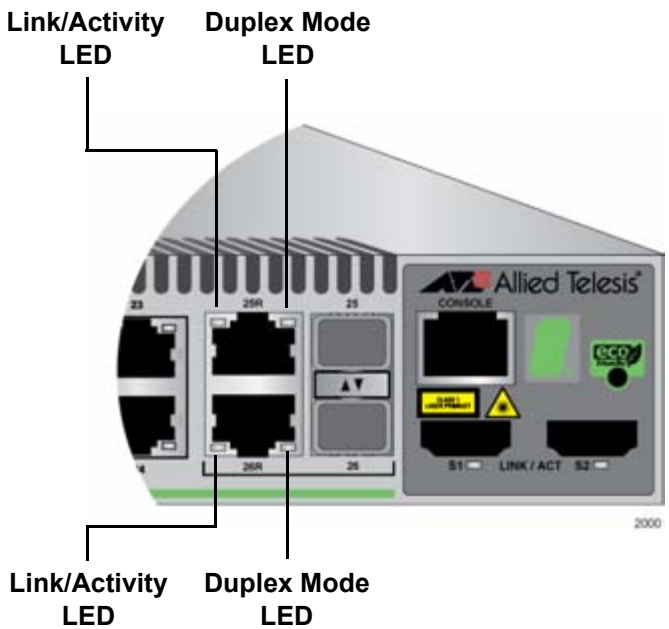

Figure 14. 10/100/1000Base-T Port LEDs

Table 12 describes the LEDs for the 10/100/1000Base-T twisted pair ports.

Table 12. 10/101000Base-T Port LEDs

LED	State	Description
Link/Activity	Off	The port has not established a link to an end node.
	Solid green	The port has established a link to an end node.
	Flashing green	The port is receiving or transmitting packets.

Table 12. 10/101000Base-T Port LEDs (Continued)

LED	State	Description
Duplex Mode	Off	The port is operating in half-duplex mode.
	Solid green	The port is operating in full-duplex mode.

100Base-FX Port LEDs

Each of the 100Base-FX ports on the AT-8100S/16F8-SC, AT-8100S/16F8-LC, and AT-8100S/24F-LC Switches has a single LED, labeled L/A for Link/Activity.



100Base-FX Port LED

Figure 15. 100Base-FX Port LED

The 100Base-FX port LED is described in Table 13.

Table 13. 100Base-FX Port LED

LED	State	Description
Link/Activity	Off	The port has not established a link to a network device.
	Solid green	The port has established a link to a network device.
	Flashing green	The port is receiving or transmitting packets to a network device.

SFP Slot LED Each SFP slot has one LED.

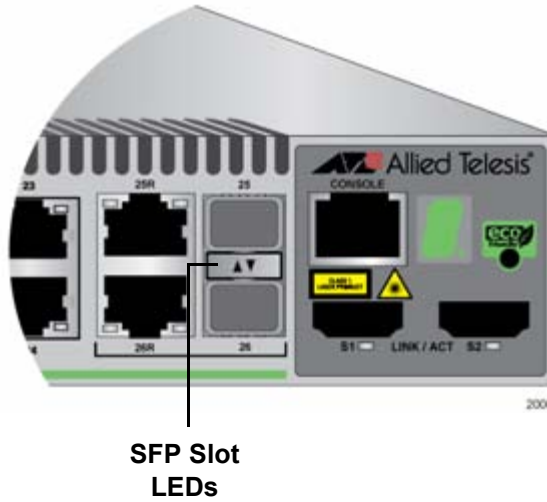

Figure 16. SFP Slot LEDs

The SFP slot LED is described in Table 14.

Table 14. SFP Slot LED

LED	State	Description
Link/Activity	Off	The SFP slot is empty or the SFP module has not established a link to a network device.
	Solid green	The SFP module has established a link to a network device.
	Flashing green	The SFP module is receiving or transmitting packets to a network device.

Stacking Port LEDs

Each stacking port has one link LED labelled LINK/ACT.

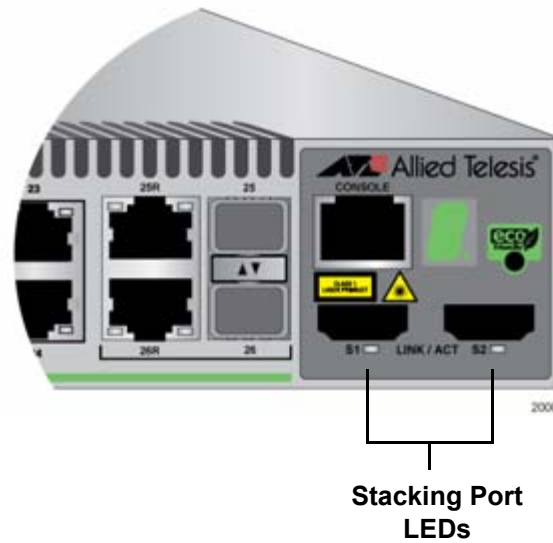

Figure 17. Stacking Port S1 and S2 LEDs

The stacking port LED is described in Table 15.

Table 15. Stacking Port S1 and S2 LEDs

LED	State	Description
LINK/ACT	Off	The stacking port is not connected to another switch or has not established a link.
	Solid green	The stacking port has established a link with a stacking port on another switch.

Note

The stacking port LEDs do not indicate packet activity.

Stack ID LED

The Stack ID LED, shown in Figure 18 on page 52, displays the ID number of the switch. A stand-alone switch should have the ID number 0. Switches connected with the stacking ports to form a virtual stack must have unique numbers. Chapter 5, “Powering On the Switch” on page 85 has the procedure for verifying and, if necessary, changing the ID number of the switch.

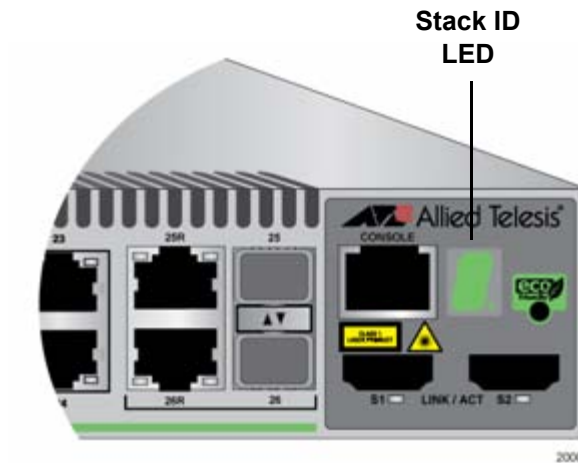

Figure 18. Stack ID LED

The 8100L Series switches do not support stacking, but they have stack ID LEDs and can be assigned ID numbers because they have the same management software as the 8100S Series switches. Given that you cannot stack 8100L Series switches, the correct ID number for these units is always “0.” Refer to Chapter 5, “Powering On the Switch” on page 85 for the procedure on how to change the ID number of the switch.

Console Port

The Console port is used to configure the features and parameter settings of the switch. This type of management uses serial RS-232 and is commonly referred to as local or out-of-band management because it is not conducted over your network. To perform local management, you must be at the location of the switch and must use the management cable included with the switch.

To establish a local management session with the switch, you connect a terminal or a personal computer with a terminal emulation program to the Console port, which has an RJ-45 style (8P8C) connector, using the provided management cable. The cable which has RJ-45 RJ-style (8P8C) and DB-9 (D-sub 9-pin) connectors.

The Console port is set to the following specifications:

- Default baud rate: 9600 bps (Range is 9600 to 115200 bps)
- Data bits: 8
- Parity: None
- Stop bits: 1
- Flow control: None

Note

These settings are for a DEC VT100 or ANSI terminal, or an equivalent terminal emulation program.

Power Supplies

The 8100L Series switches have one AC power supply. The 8100S Series switches have two AC or DC power supplies, except for the AT-8100S/24C Switch, which has one AC power supply. The supplies are not field-replaceable and each has a separate AC or DC connector on the back panels.

Only one power supply is active at a time in non-PoE 8100S Series switches. The second power supply operates in a redundant state and is automatically activated by the switch if the active power supply loses power or fails. The change over is instantaneous, making it transparent to the network users. Power redundancy is available only when both AC connectors on the switch are connected to power sources.

For all operations excluding PoE, the dual power supplies in the AT-8100S/24POE and AT-8100S/48POE Switches operate in the same manner as those in the non-PoE switches. One power supply operates in an active state while the other resides in a redundant state.

For PoE, however, the power supplies operate in a load-sharing manner, with each power supply providing 185 watts, half the total PoE budget of the switch. The maximum 370 watts power budget of PoE is only available when both power supplies are connected to power sources.

Refer to “Technical Specifications” on page 107 for the input voltage range.



Warning

Power cord is used as a disconnection device. To de-energize equipment, disconnect the power cord. *ES* E3



Warning

This unit might have more than one power cord. To reduce the risk of electric shock, disconnect all power cords before servicing the unit. *ES* E30

Power Connectors

The 8100S Series switches have two AC or DC power supply sockets on the back panels, except for the AT-8100S/24C Switch, which has one AC power supply socket. The 8100L Series switches have one AC power supply socket.

AC switches are powered on or off by connecting or disconnecting the power cords. DC switches are powered on or off by energizing or de-energizing the DC circuit breakers to which the switches are connected in the wiring closet.

Chapter 2

Beginning the Installation

The chapter contains the following sections:

- “Installation Procedures” on page 58
- “Reviewing Safety Precautions” on page 59
- “Choosing a Site for the Switch” on page 63
- “Unpacking the Switch” on page 64

Installation Procedures

You may install the switch on a table or in an equipment rack. Perform these procedures to install the switch on a table:

- ❑ “Reviewing Safety Precautions” on page 59
- ❑ “Choosing a Site for the Switch” on page 63
- ❑ “Unpacking the Switch” on page 64
- ❑ “Installing the Switch on a Table or Desktop” on page 70
- ❑ “Cabling the Networking Ports” on page 77
- ❑ “Powering On an AC Switch” on page 86 or “Powering On a DC Switch” on page 91
- ❑ “Setting the Stack ID Number” on page 95

Perform these procedures to install the unit in an equipment rack:

- ❑ “Reviewing Safety Precautions” on page 59
- ❑ “Choosing a Site for the Switch” on page 63
- ❑ “Unpacking the Switch” on page 64
- ❑ “Installing the Switch in an Equipment Rack” on page 71
- ❑ “Cabling the Networking Ports” on page 77
- ❑ “Powering On an AC Switch” on page 86 or “Powering On a DC Switch” on page 91
- ❑ “Setting the Stack ID Number” on page 95

Reviewing Safety Precautions

Please review the following safety precautions before you begin the installation procedure.

Note

The  indicates that a translation of the safety statement is available in a PDF document titled “Translated Safety Statements” posted on the Allied Telesis website at www.alliedtelesis.com.



Warning

Class 1 Laser product.  L1



Warning

Do not stare into the laser beam.  L2



Warning

Do not look directly at the fiber optic cable ends or inspect the cable ends with an optical lens.  L6



Warning

To prevent electric shock, do not remove the cover. No user-serviceable parts inside. This unit contains hazardous voltages and should only be opened by a trained and qualified technician. To avoid the possibility of electric shock, disconnect electric power to the product before connecting or disconnecting the LAN cables.  E1



Warning

Do not work on equipment or cables during periods of lightning activity.  E2



Warning

Power cord is used as a disconnection device. To de-energize equipment, disconnect the power cord.  E3



Warning

Class I Equipment. This equipment must be earthed. The power plug must be connected to a properly wired earth ground socket outlet. An improperly wired socket outlet could place hazardous voltages on accessible metal parts. *⌘* E4

Note

Pluggable Equipment. The socket outlet shall be installed near the equipment and shall be easily accessible. *⌘* E5



Caution

Air vents must not be blocked and must have free access to the room ambient air for cooling. *⌘* E6



Warning

Operating Temperatures. All the switches are designed for a maximum ambient temperature of 40° degrees C, except the AT-8100L/8POE-E Switch, which has a maximum ambient temperature of 50° degrees C.

Note

All Countries: Install product in accordance with local and National Electrical Codes. *⌘* E8



Warning

Only trained and qualified personnel are allowed to install or replace this equipment. *⌘* E14



Caution

Circuit Overloading: Consideration should be given to the connection of the equipment to the supply circuit and the effect that overloading of circuits might have on overcurrent protection and supply wiring. Appropriate consideration of equipment nameplate ratings should be used when addressing this concern. *⌘* E21



Caution

Risk of explosion if battery is replaced by an incorrect type. Replace only with the same or equivalent type recommended by the manufacturer. Dispose of used batteries according to the manufacturer's instructions.

Attention: Le remplacement de la batterie par une batterie de type incorrect peut provoquer un danger d'explosion. La remplacer uniquement par une batterie du même type ou de type équivalent recommandée par le constructeur. Les batteries doivent être éliminées conformément aux instructions du constructeur.  E22



Warning

Mounting of the equipment in the rack should be such that a hazardous condition is not created due to uneven mechanical loading.  E25

Note

Use dedicated power circuits or power conditioners to supply reliable electrical power to the device.  E27



Warning

This unit might have more than one power cord. To reduce the risk of electric shock, disconnect all power cords before servicing the unit.  E30

Note

If installed in a closed or multi-unit rack assembly, the operating ambient temperature of the rack environment may be greater than the room ambient temperature. Therefore, consideration should be given to installing the equipment in an environment compatible with the manufacturer's maximum rated ambient temperature (T_{mra}).  E35



Caution

Installation of the equipment in a rack should be such that the amount of air flow required for safe operation of the equipment is not compromised.  E36



Warning

Reliable earthing of rack-mounted equipment should be maintained. Particular attention should be given to supply connections other than direct connections to the branch circuits (e.g., use of power strips).

⌘ E37



Warning

To reduce the risk of electric shock, the PoE ports on this product must not connect to cabling that is routed outside the building where this device is located. *⌘* E40



Caution

The unit does not contain serviceable components. Please return damaged units for servicing. *⌘* E42



Warning

When you remove an SFP module from this product, the case temperature of the SFP may exceed 40° C (158° F). Exercise caution when handling with unprotected hands. *⌘* E43

Choosing a Site for the Switch

Observe these requirements when planning the installation of the switch.

- ❑ If you plan to install the switch in an equipment rack, the rack should be safely secured so that it will not tip over. Devices in a rack should be installed starting at the bottom, with the heavier devices near the bottom of the rack.
- ❑ If you plan to install the switch on a table, the table should be level and stable.
- ❑ The power outlet should be located near the switch and be easily accessible.
- ❑ The site should allow for easy access to the ports on the front of the switch, so that you can easily connect and disconnect cables, and view the port LEDs.
- ❑ The site should allow for adequate air flow around the unit and through the cooling vents on the front and rear panels. (The ventilation direction in units that have a cooling fan is from front to back, with the fan on the back panel drawing the air out of the unit.)
- ❑ The site should not expose the switch to moisture or water.
- ❑ The site should be a dust-free environment.
- ❑ The site should include dedicated power circuits or power conditioners to supply reliable electrical power to the network devices.
- ❑ The site should not be a wiring or utility box because the switch will overheat and fail from inadequate airflow.



Warning

Stand-alone switches should not be stacked on top of one another on a table or desktop because that could present a personal safety hazard if you need to move or replace switches.

Unpacking the Switch

Refer to the following tables to verify the contents of the shipping containers of the switches:

- ❑ For the AT-8100L/8, AT-8100L/8POE, and AT-8100L/8POE-E Switches, refer to Figure 19 on page 65.
- ❑ For the twisted pair and fiber optic 8100S Series switches except the AT-8100S/24C Switch, refer to Figure 20 on page 66.
- ❑ For the AT-8100S/24C Switch, refer to Figure 21 on page 67.

If any item in the shipping container is missing or damaged, contact your Allied Telesis sales representative for assistance.

Note

You should retain the original packaging material in the event you need to return the unit to Allied Telesis

8100L Series Switches

The AT-8100L/8, AT-8100L/8POE, and AT-8100L/8POE-E Switches come with the items listed in Figure 19 on page 65.



One AT-8100L/8, AT-8100L/8POE, or AT-8100L/8POE-E Switch



One 2 m (6.6 ft) local management cable with RJ-45 (8P8C) and DB-9 (D-sub 9-pin) connectors.



One short rack mounting bracket



One long rack mounting bracket



One regional AC power cord

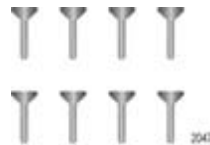

Eight bracket screws

Figure 19. Components of the 8100L Series Switches

8100S Series Switches

The 8100S Series switches, except the AT-8100S/24C Switch, come with the components listed in Figure 20.



One 8100S Series switch



One 2 m (6.6 ft) local management cable with RJ-45 (8P8C) and DB-9 (D-sub 9-pin) connectors.



One 1 m (3.3 ft) stacking cable with two type A HDMI connectors.



Two rack mounting brackets



Two regional AC power cords (Not included with DC powered switches.)

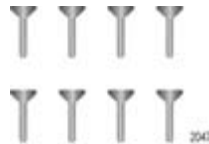

Eight bracket screws

Figure 20. Components of the 8100S Series Switches

AT-8100S/24C Switch The AT-8100S/24C Switch comes with the items listed in Figure 21.



One AT-8100S/24C Switch



One 2 m (6.6 ft) local management cable with RJ-45 (8P8C) and DB-9 (D-sub 9-pin) connectors.



One 1 m (3.3 ft) stacking cable with two type A HDMI connectors.



One short rack mounting bracket



One long rack mounting bracket



One regional AC power cord



Eight bracket screws

Figure 21. Components of the AT-8100S/24C Switch

Chapter 3

Installing the Switch on a Table or in an Equipment Rack

The procedures in this chapter are:

- “Installing the Switch on a Table or Desktop” on page 70
- “Installing the Switch in an Equipment Rack” on page 71

Installing the Switch on a Table or Desktop

You may install the switch on a table or desktop. Here are the guidelines to selecting a site:

- ❑ The table should be level and stable.
- ❑ The power outlet should be located near the switch and be easily accessible.
- ❑ The site should allow for easy access to the ports on the front of the switch, so that you can easily connect and disconnect cables, and view the port LEDs.
- ❑ The site should allow for adequate air flow around the unit and through the cooling vents on the front and rear panels. (The ventilation direction in units that have a cooling fan is from front to back, with the fans on the back panels drawing the air out of the units.)
- ❑ The site should not expose the switch to moisture or water.
- ❑ The site should be a dust-free environment.
- ❑ The site should include dedicated power circuits or power conditioners to supply reliable electrical power to the network devices.
- ❑ The rubber feet on the bottom of the switch should be left on for table or desktop installation.



Warning

Do not stack switches on top of one another on a table or desktop because that could present a personal safety hazard if you need to move or replace switches.

After placing the switch on the table or desktop, go to Chapter 4, “Cabling the Networking Ports” on page 77 to connect the network cables to the ports on the switch.

Installing the Switch in an Equipment Rack

This procedure requires the following items:

- Eight bracket screws (included with the switch)
- Two equipment rack brackets (included with the switch)
- Flat-head screwdriver (not provided)
- Cross-head screwdriver (not provided)
- Four standard equipment rack screws (not provided)

Installation guidelines may be found in “Choosing a Site for the Switch” on page 63. Here is the procedure for installing the switch in a 19-inch equipment rack.



Caution

The chassis may be heavy and awkward to lift. Allied Telesis recommends that you get assistance when mounting the chassis in an equipment rack. ⚠ E28

1. Place the unit upside down on a level, secure surface.



Figure 22. Turning the Switch Upside Down

2. Using a flat-head screwdriver, pry the rubber feet from the bottom of the switch.

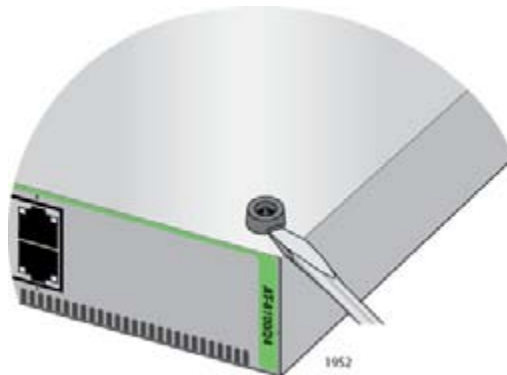

Figure 23. Removing the Rubber Feet

3. Turn the switch over.
4. For all switches except the AT-8100L/8, AT-8100L/8POE, and AT-8100S/24C Switches, secure the two rack mount brackets to the sides of the switch using the eight bracket screws included with the unit. Figure 24 here and Figure 25 on page 73 illustrate the four possible bracket positions.



Figure 24. Attaching the Brackets to Install the Switch in an Equipment Rack



Figure 25. Attaching the Brackets to Install the Switch in an Equipment Rack (Continued)

The AT-8100L/8, AT-8100L/8POE, AT-8100L/8POE-E, and AT-8100S/24C Switches come with one short bracket and one long bracket. Allied Telesis recommends installing the short bracket on the right side and the long bracket on the left side, as you face the front of the unit, so that the stacking ports on the unit align with the same ports on other 8100L and 8100S Switches in the equipment rack. The possible positions of the brackets are shown in Figure 26 on page 74 and Figure 27 on page 75.

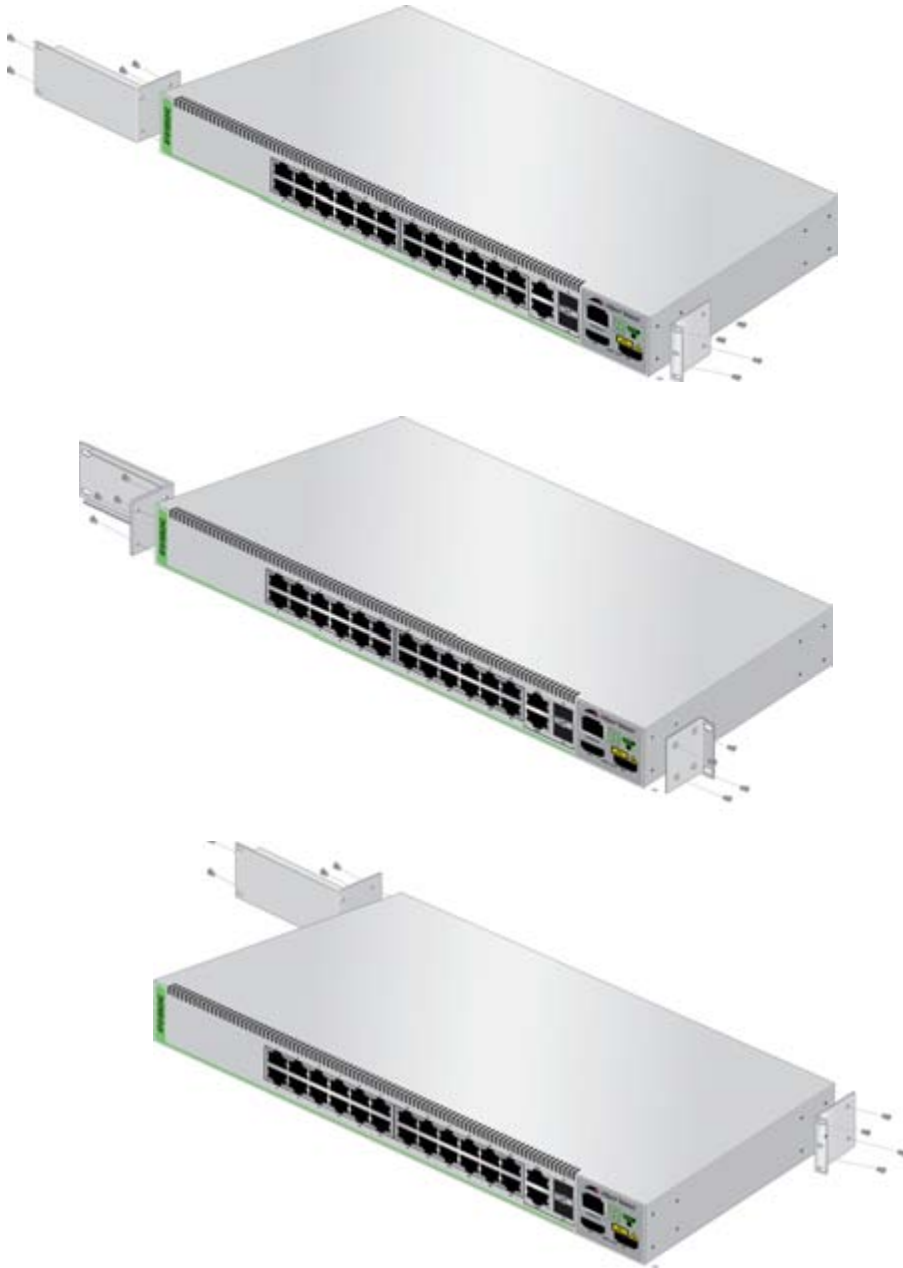

Figure 26. Attaching the Brackets to 8100L and AT-8100S/24C Switches for Equipment Rack Installation



Figure 27. Attaching the Brackets to 8100L and AT-8100S/24C Switches for Equipment Rack Installation (Continued)

5. While another person holds the switch in the equipment rack, secure it using standard equipment rack screws (not provided).



Figure 28. Mounting the Switch in an Equipment Rack

Go to Chapter 4, “Cabling the Networking Ports” on page 77 to connect the network cables to the ports on the switch.

Chapter 4

Cabling the Networking Ports

This chapter contains the following procedures:

- “Cabling the Twisted Pair and Fiber Optic Ports” on page 78
- “Installing Optional SFP Transceivers” on page 80

Cabling the Twisted Pair and Fiber Optic Ports

This section contains the guidelines to cabling the twisted pair and fiber optic ports.

Twisted Pair Ports

Here are the guidelines to cabling the 10/100Base-TX and 10/100/1000Base-T twisted pair ports:

- ❑ The cable specifications for the 10/100Base-TX and 10/100/1000Base-T twisted pair ports are listed in Table 7 on page 36 and Table 8 on page 38, respectively.
- ❑ The connectors on the cables should fit snugly into the ports, and the tabs should lock the connectors into place.
- ❑ The default setting for the wiring configurations of the ports is auto-MDI/MDI-X. The default setting is appropriate for switch ports that are connected to 10/100Base-TX network devices that also support auto-MDI/MDI-X.
- ❑ The default auto-MDI/MDI-X setting is not appropriate for switch ports that are connected to 10/100Base-TX network devices that do not support auto-MDI/MDI-X and have a fixed wiring configuration. For switch ports connected to those types of network devices, you should disable auto-MDI/MDI-X and set the wiring configurations manually.
- ❑ The appropriate MDI/MDI-X setting for a switch port connected to a 10/100Base-TX network device with a fixed wiring configuration depends on the setting of the network device and whether the switch and network device are connected with straight-through or crossover cable. If you are using straight-through twisted pair cable, the wiring configurations of a port on the switch and a port on a network device must be opposite each other, such that one port uses MDI and the other MDI-X. For example, if a network device has a fixed wiring configuration of MDI, you must disable auto-MDI/MDI-X on the corresponding switch port and manually set it to MDI-X. If you are using crossover twisted pair cable, the wiring configurations of a port on the switch and a port on a network device must be the same.
- ❑ The default speed setting for the ports is Auto-Negotiation. This setting is appropriate for ports connected to network devices that also support Auto-Negotiation.
- ❑ The default speed setting of Auto-Negotiation is not appropriate for ports connected to 10/100Base-TX network devices that do not support Auto-Negotiation and have fixed speeds. For those switch ports, you should disable Auto-Negotiation and set the port's speed manually to match the speeds of the network devices.

- ❑ The 10/100/1000Base-T ports must be set to Auto-Negotiation, the default setting, to operate at 1000Mbps.
- ❑ The default duplex mode setting for the ports is Auto-Negotiation. This setting is appropriate for ports connected to network devices that also support Auto-Negotiation for duplex modes.
- ❑ The default duplex mode setting of Auto-Negotiation is not appropriate for ports connected to network devices that do not support Auto-Negotiation and have a fixed duplex mode. You should disable Auto-Negotiation on those ports and set their duplex modes manually to avoid the possibility of duplex mode mismatches. A switch port using Auto-Negotiation defaults to half-duplex if it detects that the end node is not using Auto-Negotiation, which can result in a mismatch if the end node is operating at a fixed duplex mode of full-duplex.

Fiber Optic Ports

Here are the guidelines to cabling the 100Base-FX fiber optic ports:

- ❑ The cable specifications for the 100Base-FX fiber optic ports are listed in Table 4 on page 29.
- ❑ Do not remove the dust covers from the fiber optic ports until you are ready to connect the fiber optic cables. Dust contamination can adversely affect the operations of the ports.
- ❑ The connectors on the cables should fit snugly into the ports, and the tabs should lock the connectors into place.

General Guidelines

These guidelines apply to both the twisted pair and fiber optic ports:

- ❑ If the switch will have a static or an LACP port trunk, you should create the trunk first using the switch's management software before connecting the cables of the trunk. Otherwise, a network loop will result which can adversely affect network performance.
- ❑ If your network topology contains a loop where two or more network devices can communicate with each other over more than one network path, do not connect the network cables that form the loop until after you activate one of the spanning tree protocols on the stack. Data loops can adversely affect network performance. For background information on the spanning tree protocols, refer to the *AT-8100 Series AlliedWare Plus Command Line Interface User's Guide*.

Installing Optional SFP Transceivers

Review the following guidelines before installing optional SFP transceivers in the switch:

- ❑ The SFP slots are part of combo ports, with 10/100/1000Base-T ports. For operational information, refer to “SFP Slots” on page 39.
- ❑ SFP transceivers can be hot-swapped while the switch is powered on. However, you should always disconnect the fiber optic cable first before removing a transceiver.
- ❑ You should install the transceiver before connecting the fiber optic cable.
- ❑ Fiber optic transceivers are dust sensitive. Always keep the plug in the optical bores when a fiber optic cable is not installed, or when you store the transceiver. When you do remove the plug, keep it for future use.
- ❑ Unnecessary removal and insertion of a transceiver can lead to premature failure.



Warning

A transceiver can be damaged by static electricity. Be sure to observe all standard electrostatic discharge (ESD) precautions, such as wearing an antistatic wrist strap, to avoid damaging the device.

Note

The cable specifications of optional SFP transceivers are found in the installation guides that ship with the devices.

To install an SFP transceiver:

1. Remove the dust plug from a transceiver slot on the switch. Refer to Figure 29 on page 81.



Figure 29. Removing the Dust Plug from an SFP Slot

2. Remove the transceiver from its shipping container and store the packaging material in a safe location.
3. If you are installing the transceiver in the top SFP slot, position the transceiver with the Allied Telesis label facing up. If you are installing the transceiver in the bottom slot, position the transceiver with the label facing down.
4. Slide the transceiver into the slot until it clicks into place, as shown in Figure 30.



Figure 30. Installing an SFP Transceiver

5. Remove the dust cover from the module, as shown in Figure 31 on page 82.



Figure 31. Removing the Dust Cover from the SFP Module

6. Verify that the handle on the SFP transceiver is in the upright position, as shown in Figure 32.

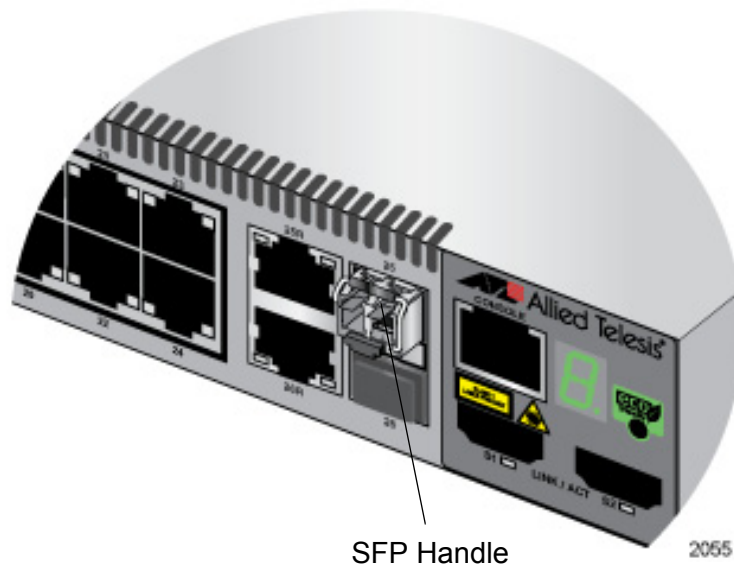

Figure 32. Positioning the SFP Handle in the Upright Position

7. Connect the fiber optic cable to the SFP module, as shown in Figure 33.

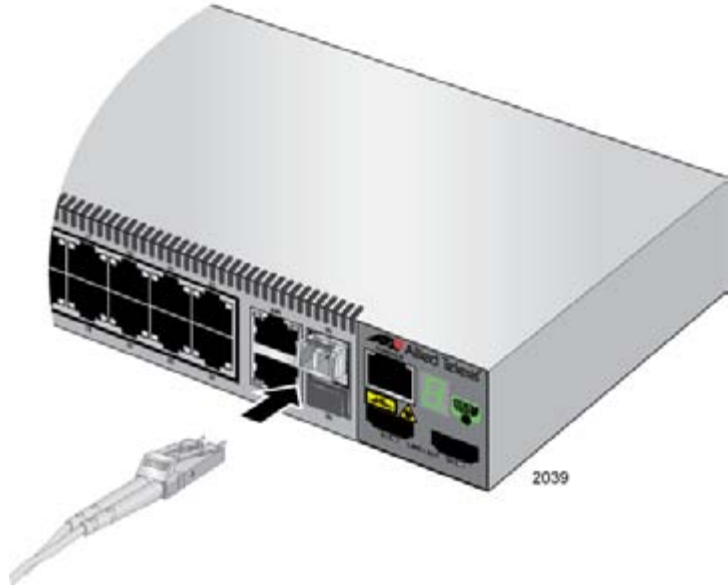

Figure 33. Connecting the Fiber Optic Cable to the SFP Module

8. Repeat this procedure if you have another SFP transceiver to install.

Chapter 5

Powering On the Switch

This chapter contains the following procedures:

- ❑ “Powering On an AC Switch” on page 86
- ❑ “Powering On a DC Switch” on page 91
- ❑ “Setting the Stack ID Number” on page 95
- ❑ “Starting a Management Session” on page 99

Powering On an AC Switch

To power on an AC switch, connect the power cords to the connectors on the back panels and to the appropriate power sources. All of the models have two power supplies with separate connectors, except for the AT-8100S/24C Switch and 8100L Series switches, which have just one power supply.



Figure 34. Plugging in the AC Power Cord

Consider the following items as you power on the switch:

- ❑ Connecting the two power cords to power sources that are on different circuits will provide power redundancy to the switch in the event a circuit fails.
- ❑ The AT-8100S/24POE and AT-8100S/48POE Switches support 370 watts of PoE only when both internal power supplies are connected to power sources. The switches have a PoE budget of 185 watts if just one power supply is functional. For background information, refer to “Power Supplies” on page 54.
- ❑ Refer to “Power Specifications” on page 109 for the power specifications of the switches.



Warning

Power cord is used as a disconnection device. To de-energize equipment, disconnect the power cord. ⚡ E3

Note

Pluggable Equipment. The socket outlet shall be installed near the equipment and shall be easily accessible. ⚡ E5

Monitoring the Initialization Processes

It takes a minimum of forty seconds for a stand-alone switch to initialize its management software programs and features, and load the configuration file. You may monitor the progress of the initialization process by watching the LEDs on the front panel. Table 16 on page 88 provides the various LED states and the approximate time intervals of the initialization phases. The time length of phase 4, loading the configuration file, varies from a few seconds to a minute, depending on the number and complexity of the commands in the file. The stack ID LED acts differently depending on whether the unit is powered on or reset with the RELOAD or RESET command.

Table 16. LEDs and Management Software Initialization

LEDs	Initialize Management Software		Initialize Features	Load Configuration File
	Phase 1: 15 seconds	Phase 2: 15 seconds	Phase 3: 10 seconds	Phase 4: varies
Base port LEDs	On	On	Off	Off
10/100/1000Base-T port and SFP slot LEDs	On	Off	Off	Off
Stack ID LED				
Power cycle	Off	Off	Flashing	On
RELOAD or RESET command	On	On	Flashing	On

The base port LEDs are on in phases 1 and 2 if they are connected to live network devices. Otherwise, they are off. The 10/100/1000Base-T port LEDs are on in phase 1 regardless of whether they are connected to active network devices.

You may also monitor the processes by connecting a terminal or computer that has a terminal emulator program, to the Console port on the master switch. You will see the messages in Figure 35 on page 89 and Figure 36 on page 90.

```

CFE-NTSW-5.0.0 for BCM956218 (32bit,SP,BE,MIPS)
Build Date: wed Jul 23 13:47:51 PDT 2008 (jwong@tiramisu)
Copyright (C) 2000, 2001, 2002, 2003, 2004, 2005 Broadcom Corporation.

Initializing Arena.
Initializing Devices.
Board : BCM956218K48
CPU type 0x2901A: 266MHz
Total memory: 0x8000000 bytes (128MB)
Total memory used by CFE:      0x87EBB000 - 0x87FFF6C0 (1328832)
Initialized Data:             0x87EFA224 - 0x87EFC4F0 (8908)
BSS Area:                     0x87EFC4F0 - 0x87EFD6C0 (4560)
Local Heap:                   0x87EFD6C0 - 0x87FFD6C0 (1048576)
Stack Area:                   0x87FFD6C0 - 0x87FFF6C0 (8192)
Text (code) segment:         0x87EBB000 - 0x87EF9AE3 (256739)
Boot area (physical):        0x07E7A000 - 0x07EBA000
Relocation Factor:           I:E82BB000 - D:E82BB000
Loader:elf Filesys:raw Dev:flash0.os-Linux File:ATI Options:(null)
Loading: 0x80001000/2341892 0x8023e000/12135086 0x80dd0aae/185714 Entry
at 0x8026c000
Starting program at 0x8026c000

/usr/bin:/bin:/usr/sbin:/sbin
Starting SNMP...
Starting MainTask...

Initializing System ..... done!
Initializing Board ..... done!
Initializing Serial Interface ..... done!
Initializing Timer Library ..... done!
Initializing IPC ..... done!
Initializing Event Log ..... done!
Initializing Switch Models ..... done!
Initializing File System ..... done!
Initializing Database ..... done!
Initializing Configuration ..... done!
Initializing AW+ CLI ..... done!
Initializing Drivers ..... done!
Initializing Port ..... done!
Initializing Trunk ..... done!
Initializing Port Security ..... done!
Initializing LACP ..... done!
Initializing PORT VLAN ..... done!
Initializing Port Mirroring ..... done!
Initializing Port Statistics ..... done!
Initializing Snmp Service ..... done!
Initializing web Service ..... done!

```

Figure 35. Switch Initialization Messages

```

Initializing Monitor ..... done!
Initializing STP ..... done!
Initializing SPANNING TREE ..... done!
Initializing L2_MGMT ..... done!
Initializing LLDP_RX ..... done!
Initializing LLDP_TX ..... done!
Initializing GARP ..... done!
Initializing GARP Post Init Task ..... done!
Initializing IGMPsnoop ..... done!
Initializing SYS_MGMT ..... done!
Initializing SWITCH_MGMT ..... done!
Initializing L2APP_MGMT ..... done!
Initializing SNMP_MGMT ..... done!
Initializing Authentication ..... done!
Initializing TCPIP ..... done!
Initializing Default VLAN ..... done!
Initializing ENCO ..... done!
Initializing PKI ..... done!
Initializing PortAccess ..... done!
Initializing PAAcctRcv ..... done!
Initializing SSH ..... done!
Initializing IFM ..... done!
Initializing IFMV6 ..... done!
Initializing RTM ..... done!
Initializing FTAB ..... done!
Initializing FTABV6 ..... done!
Initializing ACM ..... done!
Initializing Filter ..... done!
Initializing L3_MGMT ..... done!
Initializing L3APP_MGMT ..... done!
Initializing SFLOW ..... done!
Initializing NTP ..... done!
Initializing CPU_HIST ..... done!
Initializing EStacking ..... done!
Initializing MGMT_MGMT ..... done!

Loading configuration file "boot.cfg" ..... done!

Press <ENTER> key to connect...

```

Figure 36. Switch Initialization Messages (Continued)

After the switch has initialized its management software, go to “Setting the Stack ID Number” on page 95 to confirm its ID number.

Powering On a DC Switch

Perform this procedure to power on a DC 8100S Series switch:



Warning

As a safety precaution, install a circuit breaker with a minimum value of 15 Amps between the equipment and the DC power source.

Always connect the wires to the LAN equipment first before you connect the wires to the circuit breaker. Do not work with HOT feeds to avoid the danger of physical injury from electrical shock. Always be sure that the circuit breaker is in the OFF position before connecting the wires to the breaker. *↪* E9



Warning

For centralized DC power connection, install only in a restricted access area. *↪* E23

Note

A tray cable is required to connect the power source if the unit is powered by centralized DC power. The tray cable must be a UL listed Type TC tray cable and rated at 600 V and 90 degrees C, with three conductors, minimum 14 AWG. *↪* E24

1. Power off the DC circuit to which the switch will be connected.
2. Use the legend below the terminal block to identify the terminals. The terminals are **positive**, **power supply ground**, and **negative**, from left to right, as shown in Figure 37 on page 92.

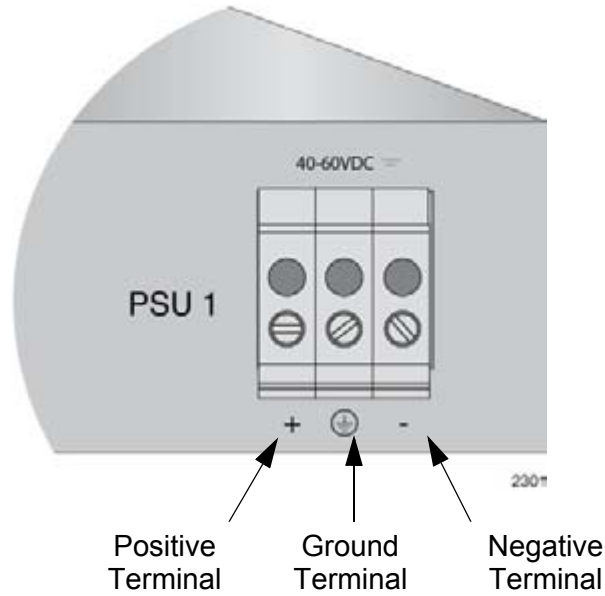



Figure 37. DC Terminal Block

3. With a 14-gauge wire-stripping tool, strip the three wires in the tray cable coming from the DC input power source to $8\text{mm} \pm 1\text{mm}$ ($0.31\text{ in.} \pm 0.039\text{ in.}$), as shown in Figure 38 on page 92.



Warning

Do not strip more than the recommended amount of wire. Stripping more than the recommended amount can create a safety hazard by leaving exposed wire on the terminal block after installation.  E10

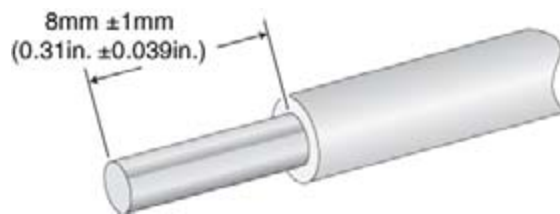



Figure 38. Stripped Wire

4. Insert the power supply ground wire into the middle connector of the DC terminal and tighten the connection with a flathead screwdriver, as shown in Figure 39 on page 93.



Warning

When installing this equipment, always ensure that the power supply ground connection is installed first and disconnected last.  E11

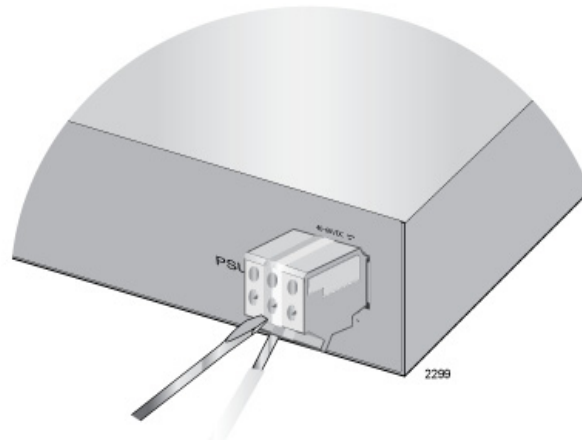

Figure 39. Inserting Wires into the DC Terminal Block

5. Connect the positive feed wire to the terminal block marked + (plus).
6. Connect the negative feed wire to the terminal block marked - (minus).



Warning

Check to see if there are any exposed copper strands coming from the installed wires. When this installation is done correctly there should be no exposed copper wire strands extending from the terminal block. Any exposed wiring can conduct harmful levels of electricity to persons touching the wires. *See* E12

7. Secure the tray cable near the rack framework using multiple cable ties to minimize the chance of the connections being disturbed by casual contact with the wiring. Use at least four cable ties, separated four inches apart. Locate the first one within six inches of the terminal block.

Note

This system will work with a positive grounded or negative grounded DC system. *See* E13

8. Verify that the circuit breaker is in the OFF position.
9. Connect the supply-cable wires to the circuit breaker.
10. Energize the circuit breaker.

It takes the switch about forty seconds to initialize its management software and activate the default settings. (A switch that has a large number of commands in its boot configuration file may require up to two minutes to initialize the software.) If you have a terminal or

computer with a terminal emulator program connected to the Console port on the switch, you will see the messages in Figure 35 on page 89 to Figure 36 on page 90.

11. Repeat this procedure to power on the second power supply.



Warning

This unit might have more than one power source. To reduce the risk of electric shock, disconnect all power cords before servicing the unit. ⚡ E30

12. Go to “Setting the Stack ID Number” on page 95 to confirm the switch’s ID number.

Setting the Stack ID Number

After the switch has initialized its management software, examine the Stack ID LED on the front panel and do one of the following:

- ❑ If the LED is displaying “0,” the installation procedure is complete. The switch is now ready for network operations as a stand-alone unit. Refer to the *AT-8100 Series AlliedWare Plus Command Line Interface User’s Guide* for instructions on how to configure the operating parameters.
- ❑ If the LED is displaying a number other than “0,” perform the following procedures to change it.

You may set the stack ID number from a local management session of the switch using the Console port or, because the switch has a factory IP address, from a Telnet management session from any of the unit’s networking ports. If you prefer to use the Console port, go to “Starting a Local Management Session,” next. To use the Telnet application protocol, go to “Starting a Telnet Management Session” on page 96. (You cannot use the web browser management interface to change the switch’s stack ID number.)



Caution

Setting the stack ID number resets the switch. Some network traffic may be lost if the device is already connected to a live network.

Starting a Local Management Session

This procedure requires a terminal or a terminal emulator program and the management cable that comes with the switch. To start a local management session on the switch, perform the following procedure:

1. Connect the RJ-45 connector on the management cable to the Console port on the front panel of the switch.

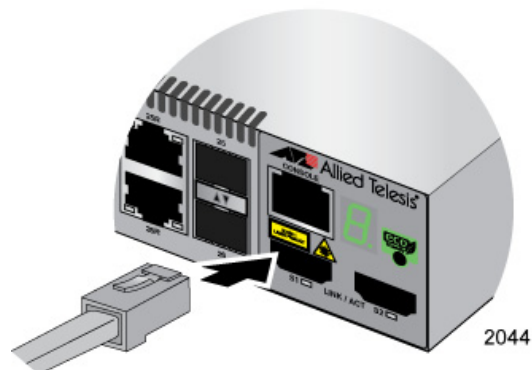

Figure 40. Connecting the Management Cable to the Console Port

2. Connect the other end of the cable to an RS-232 port on a terminal or PC with a terminal emulator program.
3. Configure the terminal or terminal emulator program as follows:
 - Baud rate: 9600 bps (The baud rate of the Console Port is adjustable from 1200 to 115200 bps. The default is 9600 bps.)
 - Data bits: 8
 - Parity: None
 - Stop bits: 1
 - Flow control: None

Note

The port settings are for a DEC VT100 or ANSI terminal, or an equivalent terminal emulator program.

4. Press Enter.

You are prompted for a user name and password.
5. When prompted for a user name, go to “Changing the Stack ID Number” on page 97.

Starting a Telnet Management Session

To perform this procedure, you must have Telnet client software on your computer. This procedure assumes that you will be connecting your computer to a twisted pair port on the switch. But you may use a fiber optic port. To start a Telnet management session on the switch using the factory IP address, perform the following procedure:

1. Assign your computer the IP address 169.254.*n.n* with the subnet mask 255.255.0.0. The variable *n* can be from 1 to 255. You may not use the switch’s IP address 169.254.1.1. Refer to your computer’s documentation for instructions on how to set the address.

Note

If your computer is running a DHCP client, it automatically defaults to an 169.254.*n.n* address if it does not receive a response from a DHCP server. To have the DHCP client assign the address, disconnect your computer from your network, power it on, wait for the DHCP client to generate the IP address 169.254.*n.n*, and then connect the computer to your new 8100L or 8100S Series switch.

2. Connect a twisted pair cable to one of the networking ports on the switch. You may connect the cable to any of the ports, except the Console port.

3. Connect the other end of the cable to the Ethernet port on your computer.
4. Start the Telnet client on your computer and specify the switch's IP address, 169.254.1.1.
5. When prompted for a user name, go to "Changing the Stack ID Number," next.

Changing the Stack ID Number

To set the stack ID number, perform the following procedure:

1. When prompted, enter a user name and password to log on the switch. If this is the initial management session of the switch, enter "manager" as the user name "friend" as the password. The user name and password are case sensitive.

The local management session starts when the AlliedWare Plus™ command line prompt, shown in Figure 41. is displayed.

```
awplus>
```

Figure 41. AlliedWare Plus Command Line Prompt

2. Enter the ENABLE and CONFIGURE TERMINAL commands to move to the Global Configuration mode.

```
awplus> enable
awplus# configure terminal
awplus(config)#
```

Figure 42. Moving to the Global Configuration Mode with the ENABLE and CONFIGURE TERMINAL Commands

3. To set the switch's ID number, use the STACK command, which has this format:

```
stack old_id renumber new_id
```

The OLD_ID parameter is the switch's current ID number, displayed on the stack ID LED. The NEW_ID parameter will be the switch's new ID number, which, for a stand-alone switch, should be 0. In this example of the command, the switch's current ID number is 1:

```
awplus(config)# stack 1 renumber 0
```

This confirmation prompt in Figure 43 is displayed.

```
*** Warning Stack renumbering requires immediate reboot ***  
Stack will restart with new Device ID, all ports will  
have new numbering and any port configurations will  
probably be lost.  
Renumber and reboot system ? (y/n):
```

Figure 43. STACK Command Confirmation Prompt



Caution

The STACK command resets the switch. If the switch is already connected to a live network, some network traffic may be lost.

4. Type Y to change the switch's ID number and reset the unit, or N to cancel the procedure.
5. Wait for the switch to initialize its management software and afterwards examine the Stack ID LED. The switch is ready for normal network operations if its stack ID number is "0." Refer to the *AT-8100 Series AlliedWare Plus Command Line Interface User's Guide* for instructions on how to configure the operating parameters. If the number is not "0," repeat this procedure.

Starting a Management Session

You may use the following methods and tools to manage stand-alone 8100L and 8100S Series switches:

- Local management
- Telnet client
- Secure shell client
- HTTP non-secure and HTTPs secure Web browser
- SNMPv1, v2C, v3

Local Management

Local management uses the Console port on the switch. It is commonly referred to as out-of-band management because the management sessions are not conducted over your network. Listed here are the requirements for local management:

- A terminal or computer with a terminal emulator program
- The management cable included with the switch.

This management method uses the command line interface, which gives you access to all of the features and parameters on the switch. For instructions on how to start a local management session, refer to “Starting a Local Management Session” on page 95.

Telnet Management

The switch has a Telnet server. You may use the server to manage the unit over your network with the Telnet application protocol. Commonly referred to as in-band management because it is conducted over the network, this management method has these requirements:

- Your management workstation must have a Telnet client.
- The Telnet server on the switch has to be activated. This is the server’s default setting.
- The switch must have an IP address. You may use the factory 169.254.1.1 address assigned to the Default VLAN, which contains all of the ports on the switch. For instructions on how to assign the switch a different address, refer to the *AT-8100 Series AlliedWare Plus Command Line Interface User’s Guide*.
- You need to assign your management workstation an IP address in the 169.254.n.n subnet or your workstation must have access to that subnet through routing devices.

Telnet management uses the Command Line Interface, giving you access to all of the features and parameter settings on the switch. For instructions on how to start a Telnet management session on the switch, refer to “Starting a Telnet Management Session” on page 96.

Telnet management sessions are not secure and are vulnerable to snooping because the packets exchanged between the switch and your workstation are sent in plain text. The security of the switch may be jeopardized if an intruder captures the packet containing your username and password. For secure remote management, use the secure shell protocol.

Secure Shell Management

Secure shell management is similar to Telnet management in that you may use it, together with the Command Line Interface, to manage all of the features and functions of the switch, from a workstation on your network. The difference is that this management method encrypts the packets exchanged by your computer and the switch to protect your management sessions.

Here are the requirements for SSH management:

- Your management workstation must have an SSH client.
- The SSH server on the switch has to be activated. The server's default setting is disabled.
- You have to create an encryption key on the switch.
- The switch must have an IP address. You may use the factory 169.254.1.1 address assigned to the Default VLAN.
- You need to assign your management workstation an IP address in the 169.254.*n.n* subnet or your workstation must have access to that subnet through routing devices.

For instructions on how to configure the switch for SSH management, refer to the *AT-8100 Series AlliedWare Plus Command Line Interface User's Guide*.

Web Browser Management

Yet another way to remotely manage the switch is with a web browser. A special web browser interface, featuring both non-secure (HTTP) and secure (HTTPS) operation, lets you monitor and configure many of the switch's features from a series of windows. The interface, however, may only be used to configure a subset of the features. To configure those features the web browser interface does not support, you have to use the command line interface from another management method.

Here are the requirements for non-secure HTTP web browser management:

- Your management workstation must have a web browser.
- The web browser server on the switch has to be activated. This is the default setting in the default BOOT.CFG and QSTART.CFG files.
- The switch must have an IP address. You may use the factory 169.254.1.1 address assigned to the Default VLAN.

- ❑ You need to assign your management workstation an IP address in the 169.254.n.n subnet or your workstation must have access to that subnet through routing devices.

Refer to the *AT-8100 Series AlliedWare Plus Command Line Interface User's Guide* for instructions on how to configure the switch for secure HTTPS web browser management.

SNMP

Refer to the *AT-8100 Series AlliedWare Plus Command Line Interface User's Guide* for instructions on how to configure the switch for SNMP management. The switch does not have any default SNMP community strings.

Specifying Ports in the Command Line Interface for Stand-alone Switches

The command line interface of the Local, Telnet, and SSH management methods gives you the ability to configure all of the features and parameters on the switch. Many of the commands have the PORT parameter, which you use to identify the networking ports on the switch. This parameter has the following format:

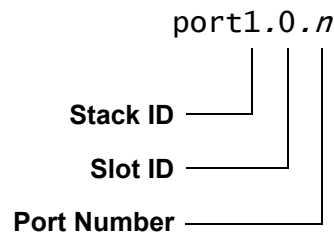

Figure 44. PORT Parameter in the Command Line Interface

The first number is the switch's stack ID number. The stack ID number in the PORT parameter for stand-alone switches is not the value 0 displayed by the Stack ID LED. Rather, it is 1. Be sure to enter 1, not 0, as the stack ID number in the PORT parameter when configuring stand-alone switches.

The slot ID value, which is used to specify slot numbers in a multi-module chassis, does not apply to the 8100L and 8100S Series switches and should always be 0.

The third value is a port number on the switch. You may specify only one port number in a PORT parameter, but you may specify more than one PORT parameter in many of the commands where the parameter is supported.

Here is an example of the PORT parameter on a stand-alone switch. It uses the INTERFACE command to enter the Port Interface mode for ports 15 and 17:

```
awplus> enable
awplus# configure terminal
awplus(config)# interface port1.0.15,port1.0.17
```

For instructions on the command line interface and the PORT parameter, refer to the *AT-8100 Series AlliedWare Plus Command Line Interface User's Guide*.

Chapter 6

Troubleshooting

This chapter contains suggestions on how to troubleshoot the switch if a problem occurs.

Note

For further assistance, please contact Allied Telesis Technical Support at www.alliedtelesis.com/support.

Problem 1: The Stack ID LED on the front of the switch is off.

Solutions: The unit is not receiving power. Try the following:

- Verify that the power cord is securely connected to the power source and to the AC connector on the back panel of the switch.
- Verify that the power outlet has power by connecting another device to it.
- Try connecting the unit to another power source.
- Try a different power cord.
- Verify that the voltage from the power source is within the required levels for your region.

Problem 2: All of the port LEDs are off even though the ports are connected to active network devices.

Solution: The switch may be operating in the low power mode. To toggle on the LEDs, press the eco-friendly button on the front panel of the switch. You may also toggle the LEDs off and on with the ECOFRIENDLY LED and NO ECOFRIENDLY LED commands in the Global Configuration mode of the command line interface.

Problem 3: A twisted pair port on the switch is connected to a network device but the port's LINK/ACT LED is off.

Solutions: The port is unable to establish a link to a network device. Try the following:

- Verify that the port is connected to the correct twisted pair cable. This is to eliminate the possibility that the port is connected to the wrong network device.

- ❑ Verify that the network device connected to the twisted pair port is powered on and is operating properly.
- ❑ Try connecting another network device to the twisted pair port with a different cable. If the twisted pair port is able to establish a link, then the problem is with the cable or the other network device.
- ❑ Verify that the twisted pair cable does not exceed 100 meters (328 feet).
- ❑ Verify that you are using the appropriate category of twisted pair cable. The cable types are listed in Table 7 on page 36 for the 10/100Base-TX ports and Table 8 on page 38 for the 10/100/1000Base-T ports.

Note

A 1000Base connection may require five to ten seconds to establish a link.

Problem 4: The LINK/ACT LED for an SFP transceiver is off.

Solutions: The fiber optic port on the transceiver is unable to establish a link to a network device. Try the following:

- ❑ Verify that the remote network device connected to the fiber optic port is operating properly.
- ❑ Verify that the fiber optic cable is securely connected to the port on the SFP module and to the port on the remote network device.
- ❑ Check that the SFP module is fully inserted in the slot.
- ❑ Verify that the operating specifications of the fiber optic ports on the SFP transceiver and the remote network device are compatible.
- ❑ Verify that the correct type of fiber optic cabling is being used.
- ❑ Verify that the port is connected to the correct fiber optic cable. This is to eliminate the possibility that the port is connected to the wrong remote network device.
- ❑ Try connecting another network device to the fiber optic port using a different cable. If the port is able to establish a link, then the problem is with the cable or with the other network device.
- ❑ Use the switch's management software to verify that the port is enabled.
- ❑ If the remote network device is a managed device, use its management firmware to determine whether its port is enabled.
- ❑ Test the attenuation of both directions on the fiber optic cable with a fiber optic tester to determine whether the optical signal is too weak (sensitivity) or too strong (maximum input power).

Problem 5: Network performance between a twisted pair port on the switch and a network device is slow.

Solution: There might be a duplex mode mismatch between the port and the network device. This occurs when a twisted pair port using Auto-Negotiation is connected to a device with a fixed duplex mode of full duplex. If this is the cause of the problem, adjust the duplex mode of the port on the network device or switch so that both ports are using the same duplex mode.

Problem 6: The switch functions intermittently.

Solutions: Check the system hardware status through the management software:

- ❑ Use the SHOW SYSTEM ENVIRONMENT command in the Privileged Exec mode to verify that the input voltage from the power source to the switch is stable and within the approved operating range. The unit will shutdown if the input voltage fluctuates above or below the approved operating range.
- ❑ For switches that have a ventilation fan, use the SHOW SYSTEM ENVIRONMENT command in the Privileged Exec mode to verify that it is operating correctly.
- ❑ Verify that the location of the switch allows for adequate airflow. The unit will shutdown if it is in danger of overheating.

Appendix A

Technical Specifications

Physical Specifications

Dimensions (H x W x D)

Table 17. Product Dimensions

AT-8100L/8 AT-8100L/8POE AT-8100L/8POE-E AT-8100S/24C	4.4 cm x 33.0 cm x 20.3 cm (1.7 in. x 13.0 in. x 8.1 in.)
AT-8100S/24 AT-8100S/48 AT-8100S/24F-LC	4.4 cm x 44.1 cm x 29.1 cm (1.7 in. x 17.3 in. x 11.5 in.)
AT-8100S/24POE AT-8100S/48POE AT-8100S/16F8-SC AT-8100S/16F8-LC	4.4 cm x 44.1 cm x 32.2 cm (1.7 in. x 17.3 in. x 12.7 in.)

Weights

Table 18. Product Weights

AT-8100L/8	1.9 kg (4.2 lb.)
AT-8100L/8POE	2.3 kg (5.1 lb.)
AT-8100L/8POE-E	2.3 kg (5.1 lb.)
AT-8100S/24C	2.2 kg (4.8 lb.)
AT-8100S/24	3.6 kg (8.0 lb.)
AT-8100S/24POE	5.0 kg (11.0 lb.)
AT-8100S/48	4.0 kg (8.9 lb.)
AT-8100S/48POE	5.6 kg (12.3 lb.)
AT-8100S/16F8-SC	4.1 kg (9.1 lb.)

Table 18. Product Weights (Continued)

AT-8100S/16F8-LC	4.4 kg (9.75 lb.)
AT-8100S/24F-LC	4.4 kg (9.75 lb.)

Ventilation

Table 19. Ventilation Requirements

Recommended Minimum Ventilation on All Sides	10 cm (4.0 in)
--	----------------

Environmental Specifications

Table 20. Environmental Specifications for all Switches Except the AT-8100L/8POE-E Switch

Operating Temperature	0° C to 40° C (32° F to 104° F)
Storage Temperature	-25° C to 70° C (-13° F to 158° F)
Operating Humidity	5% to 90% noncondensing
Storage Humidity	5% to 95% noncondensing
Maximum Operating Altitude	3,048 m (10,000 ft)
Maximum Nonoperating Altitude	4,000 m (13,100 ft)

Table 21. Environmental Specifications for the AT-8100L/8POE-E Switch

Operating Temperature	0° C to 50° C (32° F to 122° F)
Storage Temperature	-25° C to 70° C (-13° F to 158° F)
Operating Humidity	5% to 90% noncondensing
Storage Humidity	5% to 95% noncondensing
Maximum Operating Altitude	3,048 m (10,000 ft)
Maximum Nonoperating Altitude	4,572 m (15,100 ft)

Power Specifications

Maximum Power Consumptions

Table 22. Maximum Power Consumptions

AT-8100L/8	9.1 watts
AT-8100L/8POE	229.1 watts
AT-8100L/8POE-E	229.1 watts
AT-8100S/24C	18.3 watts
AT-8100S/24	19.5 watts
AT-8100S/24POE	459.3 watts
AT-8100S/48	23.2 watts
AT-8100S/48POE	462.9 watts
AT-8100S/16F8-SC	22 watts
AT-8100S/16F8-LC	22 watts
AT-8100S/24F-LC	22 watts

Input Voltages

Table 23. Input Voltages

AT-8100L/8	AC model: 100-240 VAC, 1.0 A maximum, 50/60 Hz
AT-8100L/8POE	AC model: 100-240 VAC, 3.0 A maximum, 50/60 Hz per input
AT-8100L/8POE-E	AC model: 100-240 VAC, 3.0 A maximum, 50/60 Hz per input
AT-8100S/24C	AC model: 100-240 VAC, 1.0 A maximum, 50/60 Hz per input
AT-8100S/24	AC model: 100-240 VAC, 1.0 A maximum, 50/60 Hz per input DC model: 40-60 VDC, 1.5 A maximum per input
AT-8100S/24POE	AC model: 100-240 VAC, 3.0 A maximum, 50/60 Hz per input

Table 23. Input Voltages (Continued)

AT-8100S/48	AC model: 100-240 VAC, 1.0 A maximum, 50/60 Hz per input
AT-8100S/48POE	AC model: 100-240 VAC, 3.0 A maximum, 50/60 Hz per input
AT-8100S/16F8-SC	AC model: 100-240 VAC, 1.0 A maximum, 50/60 Hz per input
AT-8100S/16F8-LC	AC model: 100-240 VAC, 1.0 A maximum, 50/60 Hz per input
AT-8100S/24F-LC	AC model: 100-240 VAC, 1.0 A maximum, 50/60 Hz, per input

Certifications

Table 24. Product Certifications

EMI (Emissions)	FCC Class A, EN55022 Class A, EN61000-3-2, EN61000-3-3, VCCI Class A, CISPR Class A, C-TICK, CE
EMC (Immunity)	EN55024
Electrical and Laser Safety	EN60950-1 (TUV), UL 60950-1 (cUL _{US}), EN60825
Compliance Marks	CE, cUL _{US} , TUV, C-Tick

Quality and Reliability

Table 25. MTBF

AT-8100L/8	830,000 hours
AT-8100L/8POE	130,000 hours
AT-8100L/8POE-E	130,000 hours
AT-8100S/24C	510,000 hours
AT-8100S/24	430,000 hours
AT-8100S/24POE	70,000 hours

Table 25. MTBF (Continued)

AT-8100S/48	300,000 hours
AT-8100S/48POE	61,000 hours
AT-8100S/16F8-SC	190,000 hours
AT-8100S/16F8-LC	170,000 hours
AT-8100S/24F-LC	140,000 hours

RJ-45 Twisted Pair Port Pinouts

Figure 45 illustrates the pin layout of the RJ-45 connectors and ports.

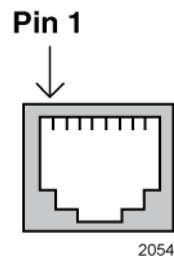

Figure 45. RJ-45 Socket Pin Layout (Front View)

Table 26 lists the pin signals for 10 and 100 Mbps.

Table 26. Pin Signals for 10 and 100 Mbps

Pin	MDI Signal	MDI-X Signal
1	TX+	RX+
2	TX-	RX-
3	RX+	TX+
4	Not used	Not used
5	Not used	Not used
6	RX-	TX-
7	Not used	Not used
8	Not used	Not used

Table 27 lists the pin signals when a port operating at 1000 Mbps.

Table 27. Pin Signals for 1000 Mbps

Pinout	Pair
1	Pair 1 +
2	Pair 1 -
3	Pair 2 +
4	Pair 3 +
5	Pair 3 -
6	Pair 2 -
7	Pair 4 +
8	Pair 4 -

Fiber Optic Port Specifications

Table 28 lists the specifications of the 100Base-FX fiber optic ports on the AT-8100S/16F8-SC Switch.

Table 28. Fiber Optic Port Specifications for the AT-8100S/16F8-SC Switch

General	
Maximum Distance	2 km
Fiber Optic Cable	50/125 or 62.5/125 μm (core/cladding) multimode fiber optic cable
Transmitter	
Wavelength	1310 nm
Output optical power with 50/125 μm (core/cladding) multimode fiber optic cable (BOL)	minimum: -22.5 dBm maximum: -14 dBm
Output optical power with 62.5/125 μm (core/cladding) multimode fiber optic cable (BOL)	minimum: -19 dBm maximum: -14 dBm

Table 28. Fiber Optic Port Specifications for the AT-8100S/16F8-SC Switch (Continued)

Receiver	
Wavelength	1310 nm
Sensitivity	Maximum: -31.8 dBm
Maximum Input Power	Minimum: -14 dBm

Table 29 lists the specifications of the 100Base-FX fiber optic ports on the AT-8100S/16F8-LC and AT-8100S/24F-LC Switches.

Table 29. Fiber Optic Port Specifications for the AT-8100S/16F8-LC and AT-8100S/24F-LC Switches

General	
Maximum Distance	2 km
Fiber Optic Cable	50/125 or 62.5/125 μm (core/cladding) multimode fiber optic cable
Transmitter	
Wavelength	1310 nm
Output optical power with 50/125 μm (core/cladding) multimode fiber optic cable (BOL)	Minimum: -23.5 dBm Maximum: -14 dBm
Output optical power with 62.5/125 μm (core/cladding) multimode fiber optic cable (BOL)	Minimum: -20 dBm Maximum: -14 dBm
Receiver	
Wavelength	1310 nm
Sensitivity	Maximum: -31 dBm
Maximum Input Power	Minimum: -8 dBm

RJ-45 Style Serial Console Port Pinouts

Table 30 lists the pin signals of the RJ-45 style serial Console port.

Table 30. RJ-45 Style Serial Console Port Pin Signals

Pin	Signal
1	Looped to pin 8.
2	Looped to pin 7.
3	Transmit Data
4	Ground
5	Ground
6	Receive Data
7	Looped to pin 2.
8	Looped to pin 1.

Stacking Port Pinouts

Figure 46 illustrates the pin layout of the S1 and S2 stacking ports.

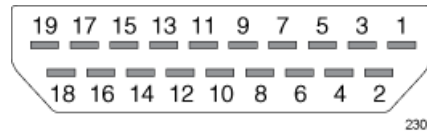

Figure 46. Stacking Port Pin Layout (Front View)

Table 31 lists the pin signals of the stacking ports.

Table 31. Stacking Port Pin Signals

Pin	S1 Port	S2 Port
1	Not connected	Not connected
2	Ground	Ground
3	Not connected	Not connected

Table 31. Stacking Port Pin Signals (Continued)

Pin	S1 Port	S2 Port
4	Transmit data1+	Receive data1+
5	Ground	Ground
6	Transmit data1-	Receive data1-
7	Receive data0+	Transmit data0+
8	Ground	Ground
9	Receive data0-	Transmit data0-
10	Not connected	Not connected
11	Ground	Ground
12 to 19	Not connected	Not connected

