



Web Guide

WV-S85702-F3L/ WV-S85402-V2L/
WV-U85402-V2L

Contents

| | |
|--|-----------|
| 1. Product Features | 1 |
| 2. Set up | 2 |
| 2.1 Install on the ceiling | 2 |
| 2.1.1 Wire from the ceiling and install | 2 |
| 2.2 Install on the wall | 2 |
| 2.2.1 Install directly on the wall | 2 |
| 2.2.2 Install using Wall Mount Bracket | 2 |
| 2.3 Easy installation | 2 |
| 3. Connect to the camera | 7 |
| 3.1 IP Setting Software | 7 |
| 3.2 Access the camera | 7 |
| 3.3 About Live image pages | 9 |
| 4. Set the camera | 10 |
| 4.1 Check whether the object is of the appropriate size | 10 |
| 4.2 Adjust the image quality | 10 |
| 4.2.1 Set the light intensity control mode depending on the installation location and installation area. | 10 |
| 4.2.2 Set white balance depending on the lighting environment you install | 11 |
| 4.2.3 Set how to switch between black-and-white and color modes at night | 12 |
| 4.3 Record setting (SD Memory Card) | 12 |
| 4.3.1 Install the SD Memory Card | 12 |
| 4.3.2 Record using SD Memory Card | 13 |
| 4.3.3 Play back images stored on the SD Memory Card | 13 |
| 4.4 Set up events | 14 |
| 4.4.1 Detect the movement of the object | 14 |
| 4.5 Enhance communication security | 15 |
| 4.6 Detect data falsification | 15 |

| | | |
|-----------|---|-----------|
| 4.7 | Set the resolution and frame rates | 15 |
| 4.8 | Set the overlay image function | 16 |
| 4.9 | Set the image stream | 16 |
| 4.9.1 | About the Setting of Stream | 16 |
| 4.9.2 | About delivery volume control (bit rate) | 16 |
| 4.9.3 | Reducing Data Capacity with Smart Coding | 17 |
| 4.10 | Adjust the zoom/focus | 18 |
| 4.11 | Hide some of the images | 18 |
| 4.12 | Identify sounds with AI | 18 |
| 4.13 | Record sound | 19 |
| 4.14 | i-PRO Configuration Tool (iCT) | 19 |
| 5. | Clean up | 20 |
| 5.1 | Cleaning of lenses | 20 |
| 5.2 | Cleaning of Dome covers | 20 |
| 6. | Specifications | 21 |
| 6.1 | PC environment required | 21 |
| 6.2 | Image capture mode and Image capture size | 21 |
| 6.2.1 | Restrictions | 22 |
| 6.3 | DORI | 23 |
| 6.4 | Delivery performance | 23 |
| 6.5 | About the Function Extension Software Available | 23 |
| 6.6 | Lamp | 24 |
| 6.6.1 | Lighting of the lamp | 25 |
| 6.7 | Button | 26 |
| 6.8 | Cable | 27 |
| 6.9 | MicroSD memory card slot | 27 |
| 7. | Other | 29 |
| 7.1 | Initialize | 29 |
| 7.2 | Check the software version | 29 |
| 7.3 | Upgrade software | 30 |
| 7.4 | Order of setting when adjusting image quality | 30 |

| | | |
|--------|--|----|
| 7.5 | Adjust brightness of the object (bright scenes) | 31 |
| 7.5.1 | Adjusting brightness | 31 |
| 7.6 | Adjust the brightness of the object (dark scenes) | 31 |
| 7.6.1 | Adjust the maximum gain | 31 |
| 7.6.2 | Adjust the maximum exposure time | 32 |
| 7.7 | Reduce white flickering and blacking on the screen | 33 |
| 7.7.1 | Set Super Dynamic | 33 |
| 7.7.2 | Set the back light compensation | 33 |
| 7.7.3 | Set the high light compensation | 34 |
| 7.7.4 | Adjust the adaptive black stretch | 35 |
| 7.7.5 | Adjust the [Pedestal level] | 35 |
| 7.8 | Adjust the contrast of the object | 36 |
| 7.8.1 | Adjust the contrast | 36 |
| 7.9 | Reduce flicker | 36 |
| 7.10 | Reduce the blur of an object (bright scene) | 36 |
| 7.10.1 | Set intelligent auto (motion priority level) | 36 |
| 7.10.2 | Adjust the maximum exposure time | 37 |
| 7.11 | Reduce the blur of an object (dark scene) | 38 |
| 7.11.1 | Adjust digital noise reduction | 38 |
| 7.12 | Sharpen the contour of the object | 39 |
| 7.12.1 | Adjust the sharpness level | 39 |
| 7.13 | Adjust the color | 39 |
| 7.13.1 | Adjust color density | 39 |
| 7.13.2 | Adjust the white balance | 40 |
| 7.14 | Reduce object noise (bright scene) | 40 |
| 7.14.1 | Adjust the sharpness level | 40 |
| 7.15 | Reduce object noise (dark scene) | 41 |
| 7.15.1 | Adjust digital noise reduction | 41 |
| 7.16 | Set focus when switching between the color mode and the black & white mode. | 41 |
| 7.16.1 | Focus adjustment method upon switching between the color mode and the black & white mode | 41 |
| 7.17 | Troubleshooting | 42 |
| 7.18 | Precautions pertaining to usage | 54 |
| 7.19 | Disclaimer | 55 |



7.20 Network security 57



1. Product Features

This unit is a Dome surveillance cameras used outdoors.

- Two camera units capable of independent orientation adjustment can be installed, and two can be shot simultaneously.
- The AI function reduces the load on the entire system by identifying objects (people/vehicles) and analyzing images.<WV-S85702-F3L><WV-S85402-V2L>
- You can install up to four AI apps.<WV-S85702-F3L><WV-S85402-V2L>
- FIPS 140-2 level 3 is equipped with a secure chip (Secure Element) that achieves a high level of cyber security.

FIPS (Federal Information Processing Standards) is a standard and guideline issued by the U.S. Federal Information and Technology Agency (NIST) for U.S. federal computer systems.

2. Set up



Please refer to the following manual for details of installation.

[Installation Guide](#)

2.1 Install on the ceiling

2.1.1 Wire from the ceiling and install

The URL of the movie is as follows.

<https://youtu.be/4OwG9iXxP74>

2.2 Install on the wall

2.2.1 Install directly on the wall

The URL of the movie is as follows.

<https://youtu.be/92kW2woGVKw>

2.2.2 Install using Wall Mount Bracket

The URL of the movie is as follows.

<https://youtu.be/OPxhDu9mr4Y>

2.3 Easy installation

This section describes the settings that support the adjustment of the angle of view when installing

2. Set up
2.3 Easy installation

the camera.

- Live image pages configuration panels>[Detailed setting]>[Camera detailed setting]>[Display]>Advanced Menu>[Easy Setup]>>Click [Easy installation] to display the easy installation page.

1. Select the installation method from the four displayed patterns.

The display layout, camera display position, and image rotation are automatically set as shown in the table below according to the selected installation method.

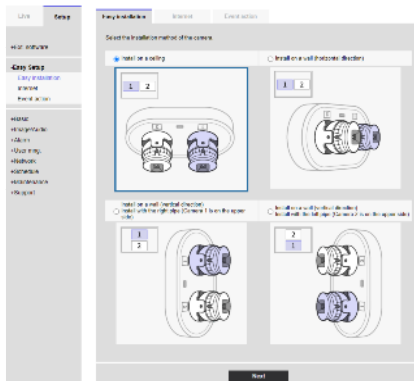

| | Display layout | Camera display position | Image Rotation |
|--|----------------------|-----------------------------------|--|
| Install on a ceiling | Left/right placement | Left: Camera 1 Right: Camera 2 | Camera 1: 0° (Off) Camera 2: 0° (Off) |
| Install on a wall (horizontal direction) | Left/right placement | Left: Camera 1 Right: Camera 2 | Camera 1: 180° (Upside-down) Camera 2: 180° (Upside-down) |
| Install on a wall (vertical direction) Install with the right pipe (camera 1 is on the upper side).*1 | Up/Down placement | Up: Camera 1 Down: Camera 2 | Camera 1: 0° (Off) Camera 2: 180° (Upside-down) |
| Install on a wall (vertical direction) | Up/Down placement | Up: Camera 2 Down: Camera 1 | Camera 1: 180° (Upside-down) |

2. Set up
2.3 Easy installation

| | | | |
|--|--|--|--------------------|
| Install with the left pipe (Camera 2 is on the upper side) ^{*2} | | | Camera 2: 0° (Off) |
|--|--|--|--------------------|

*1 When installing on a wall (horizontal direction), move the camera as shown in the illustration below before adjusting the direction of the camera.

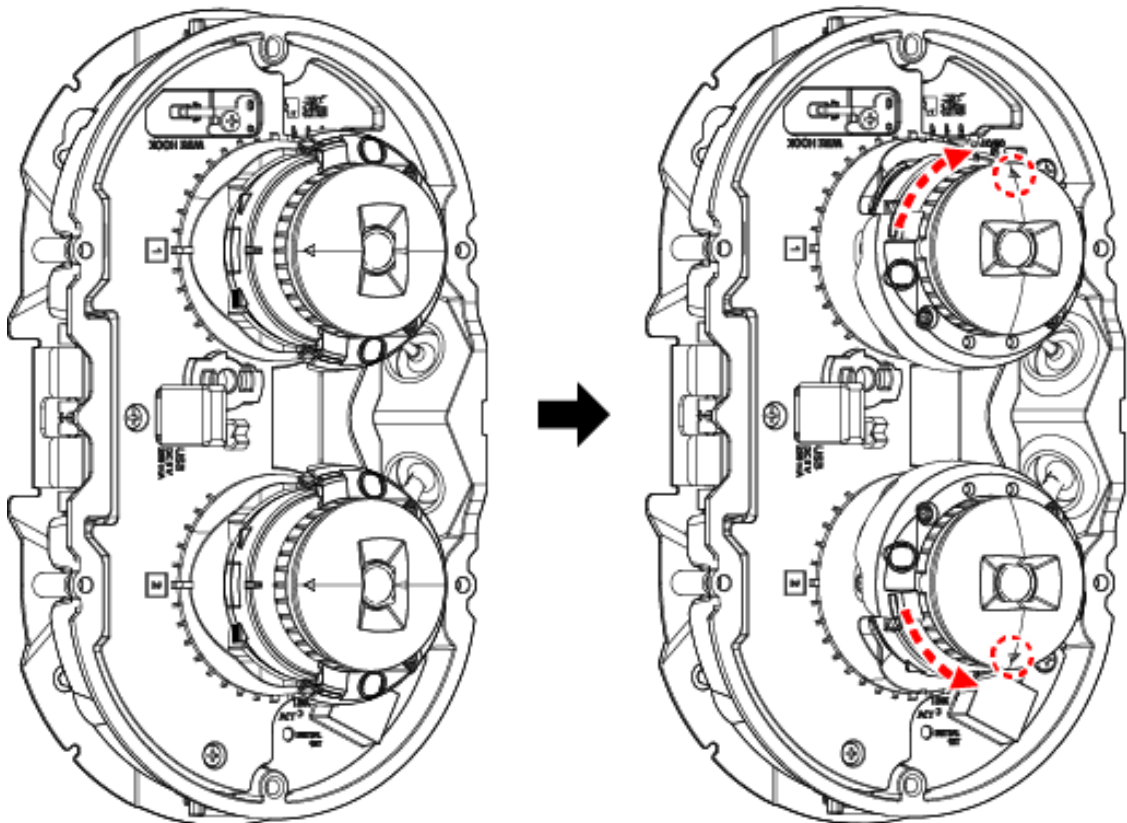

*2 When installing on a wall (vertical direction), move the camera as shown in the illustration below before adjusting the direction of the camera.

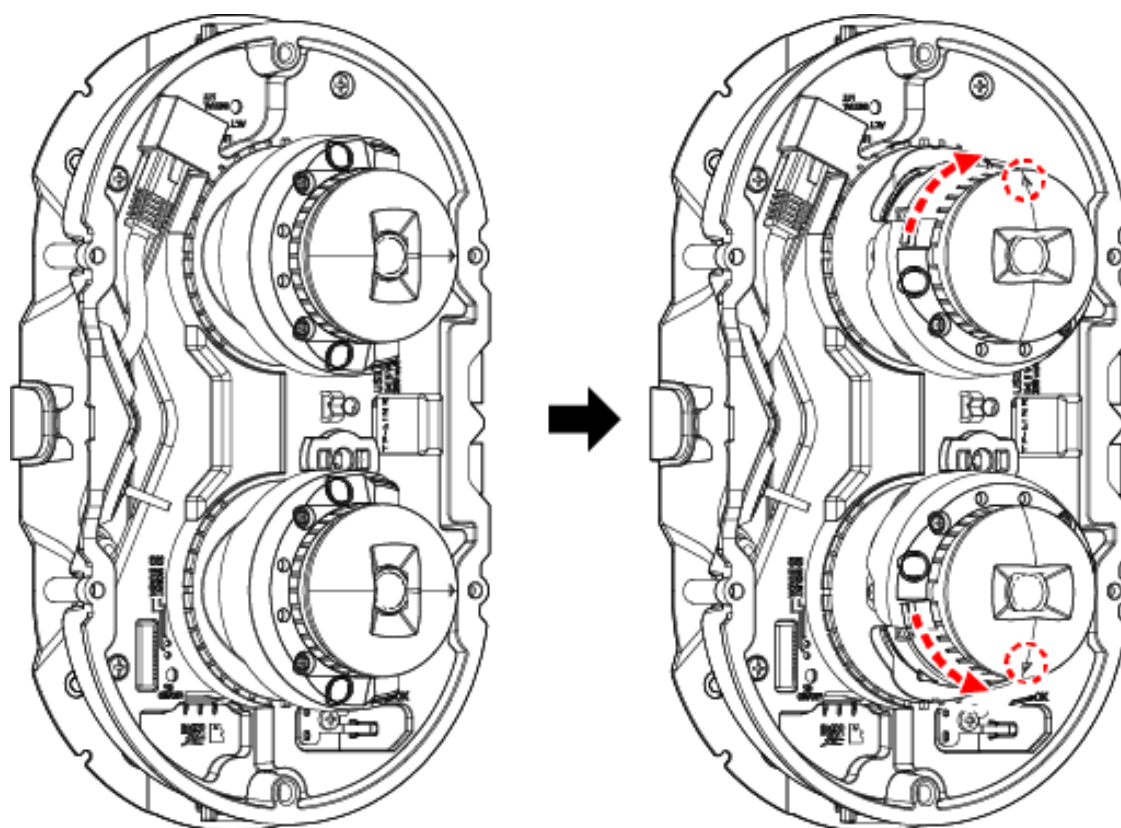

1. While checking the screen, manually adjust the direction of each camera.
2. Adjust the angle of view using the zoom button.<WV-S85402-V2L><WV-U85402-V2L>

When the display layout is set to the left/right When the display layout is set up/down

2. Set up
2.3 Easy installation

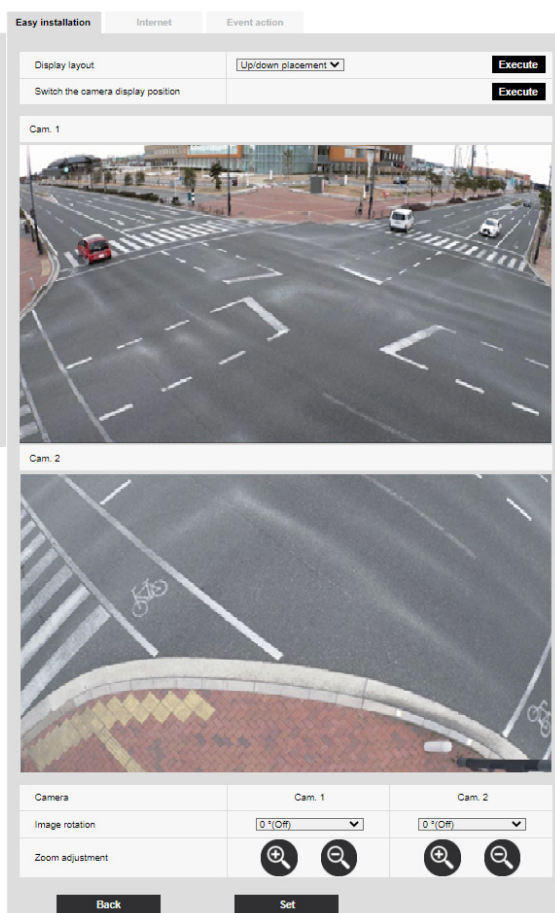
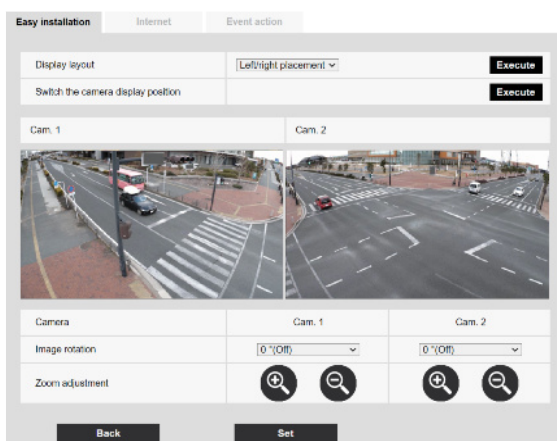

- 3. Connect to the camera
 - 3.2 Access the camera
-

3. Connect to the camera

3.1 IP Setting Software

Cameras or recorders on the same network can be automatically detected and set up in the network.



Refer to the following for details on the IP Setting Software.

→ [Click here for more information on the IP Setting Software](#)

3.2 Access the camera

1. Launch a IP Setting Software
 - The model number and MAC address of the detected camera are displayed.
 - The default setting for [Network Settings] is [DHCP].



• If you cannot obtain an IP address from the DHCP server, set the IP address to 192.168.0.10.

2. Double-click on the camera's IP address
 - The browser starts and the administrator registration screen is displayed.
 - Double-click the IP address. Administrator registration is required.

3. Connect to the camera
 - 3.2 Access the camera
-

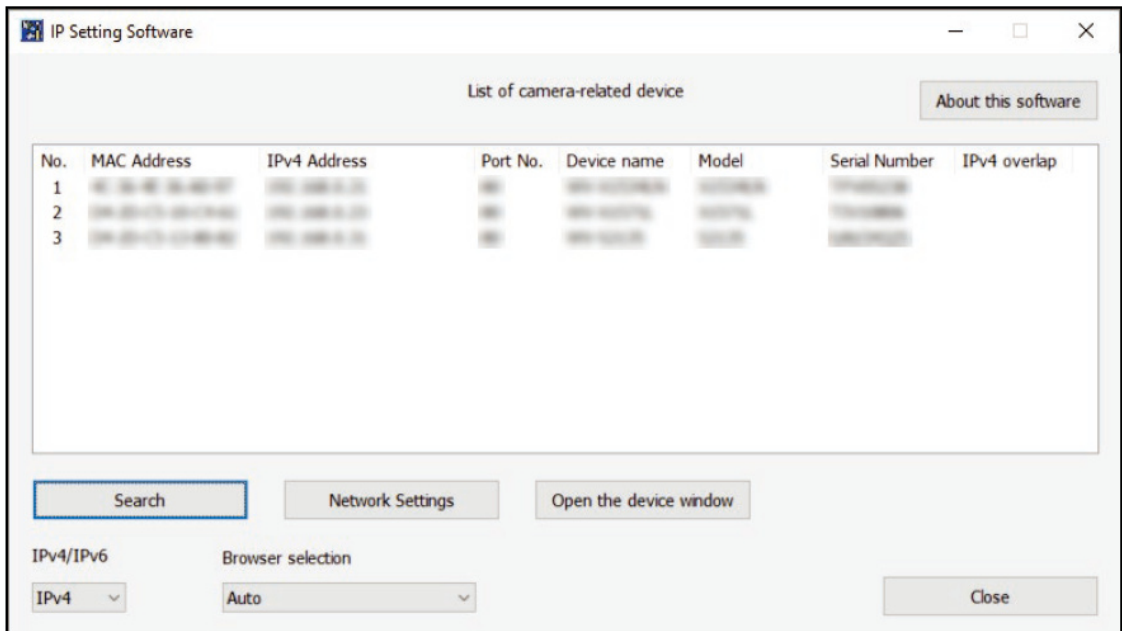

3. Enter administrator username and password
 - The language and date/time setting screen is displayed..
4. Set the language, date and time, and screen
 - You can set the language and date and time and change the background color of the screen and the layout of the operation panel.
5. Click [Set]
 - Live image pages is displayed.

- 3. Connect to the camera
 - 3.3 About Live image pages
-

3.3 About Live image pages

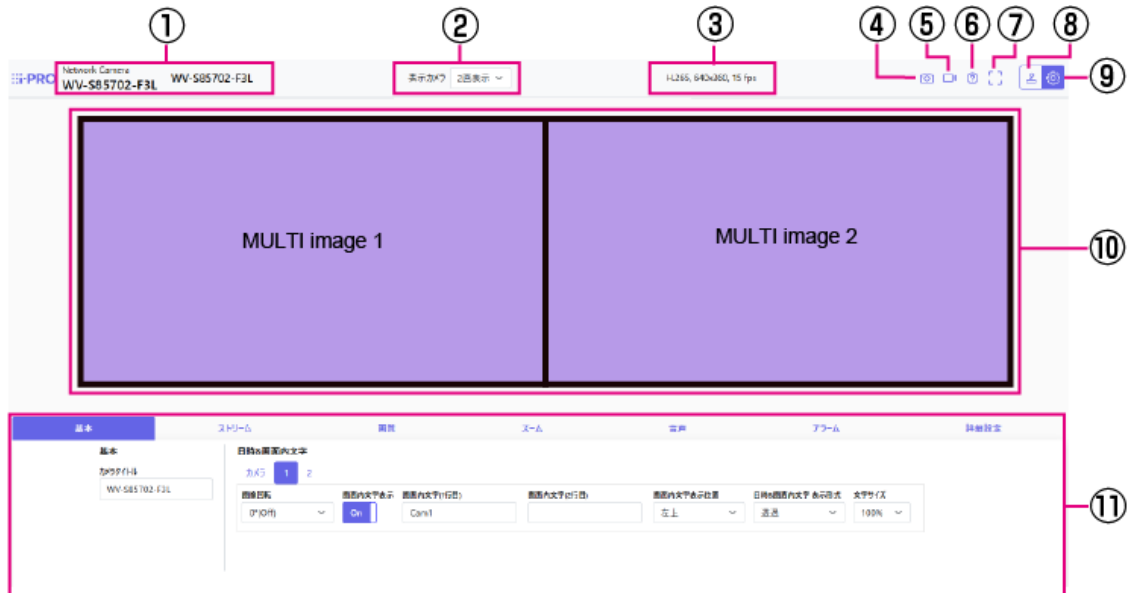

- ① Camera title
- ② [Camera to be displayed]
- ③ Stream information display
- ④ Snapshot button
- ⑤ Stream selection display button
- ⑥ Support button
- ⑦ Full Screen button
- ⑧ Camera control panel display button
- ⑨ [Set] buttons
- ⑩ Main area
- ⑪ Basic settings are available on the [Basic] tabs.

4. Set the camera

4.1 Check whether the object is of the appropriate size

When using our function extension software, you can check the number of grids to see if the size is adequate to recognize the object.

→[For more information about the recommended size of the extension software](#)

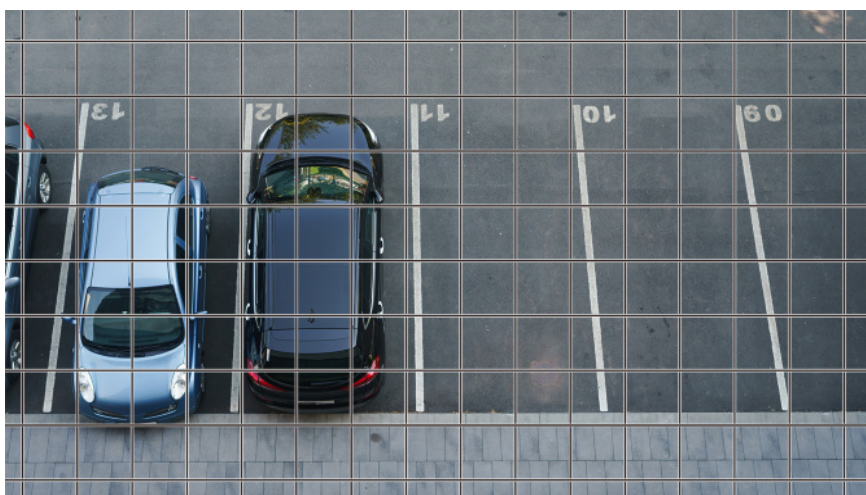

4.2 Adjust the image quality

This section explains how to adjust the image quality when installing the camera.

4.2.1 Set the light intensity control mode depending on the installation location and installation area.

Use [Light control mode] to set the light intensity appropriate for the installation location and area.

- Live image pages configuration panels>Clicking the [Image quality] tab enables you to set the image quality.

4. Set the camera

4.2 Adjust the image quality

1. Select [Light control mode]
 - For outdoor installation: Set [ELC].
 - For indoor installation: Set [Indoor scene(50Hz)] or [Indoor scene(60Hz)].
50 Hz/60 Hz can be used differently depending on the region.

4.2.2 Set white balance depending on the lighting environment you install

Use [White balance] to set the white balances appropriate for the installation location and area.

- Live image page setup panel>[Detailed setting]>[Camera detailed setting]>[Image] or [Image/Audio] in the Advanced menu on the left>[Image adjust] in the [Image quality] tab> Click [Setup] to display the image quality adjustment setting screen.

- (1) Select [White balance]
 - Select from [ATW1], [ATW2], and [AWC].

[ATW1]

Set the automatic color temperature tracking mode. The camera continuously checks the color temperature of the light source and automatically adjusts the white balance.
operating range is about 2700 K to 6000 K.

[ATW2]

Set the automatic color temperature tracking mode. The camera automatically adjusts the white balance under a sodium lamp.

The operating range is from about 2000 K to 6000 K.

[AWC]

Set the automatic white balance control mode. Since the light source is fixed, it is suitable for shooting in a place where the lighting environment does not change.

The operating range is from about 2000 K to 10000 K.



Colors may not be reproducible faithfully in the following conditions. In such cases, set it to [AWC].

- Mostly dark colored objects
- Clear blue sky or the sun at dusk
- Object with very low illumination

4.2.3 Set how to switch between black-and-white and color modes at night

When shooting at night, use [Day & Night(IR)] to set the mode suitable for the night shooting condition.

➤ Live image pages configuration panels>Clicking the [Image quality] tabs enables you to set the image quality.

1. Select [Day & Night(IR)]

- Basically, select from [Off], [Auto1(IR Light Off)], and [Auto2(IR Light On)].

[Off]

This function is used for shooting colored images at night as well.

[Auto1(IR Light Off)]

The color mode and black & white mode are automatically switched depending on the brightness (illumination) of the image.

Select this when the built-in IR-LED is not used (for example, when an external IR-LED is used).

[Auto2(IR Light On)]

The color mode and black & white mode are automatically switched depending on the brightness (illumination) of the image.

Select this when using the built-in IR-LED.

4.3 Record setting (SD Memory Card)

4.3.1 Install the SD Memory Card

- (1) Remove the enclosure
- (2) Insert a microSD memory card into the slot



Use the SD Memory Card formatted on this unit.



To remove the SD Memory Card, select [SD memory card] [Not use] from the [Basic] > [SD memory card] tabs in the Advanced menu. Then, turn the power off and remove the SD Memory Card.

4.3.2 Record using SD Memory Card

Set the schedule type to [SD memory recording] and record on an SD. This section describes the procedures for turning [Save trigger] to [Manual save].

Refer to the following for how to mount the SD card.

→ [Install the SD Memory Card](#)

- Live image page setup panel > [Detailed setting] > [Camera detailed setting] > [Display] > Advanced Menu > [Basic] > When [SD memory card] is clicked, the SD Memory Card setup page is displayed.
- (1) Select [Recording format] streams
- (2) Select [Save trigger] and click [Set].
- (3) Click [Live] in the upper left corner and click the camera control panel button.
 - The camera control panel is displayed.
- (4) Click [Start] on [Rec. on SD]
 - Start recording to the SD Memory Card manually.
 - You can stop recording by clicking [Stop]. After stopping, you can resume recording by clicking [Start].

4.3.3 Play back images stored on the SD Memory Card

You can play back images stored on the SD Memory Card.

- Camera control panel of the live image page > Clicking [Playback of recording (Log disp.)] displays the log list.
- (1) Display the live image page and click the camera control panel button.
- (2) Click the [Log/Play] [Start] button
 - The Log List screen is displayed in a separate window.
- (3) Click the shooting date and time displayed below [Time]
 - The playback page is displayed and the saved image is played.

4.4 Set up events

You can set an alarm to detect the operation of an area, interference to the camera, and noise, or set the operation when an alarm is detected.

- Live image page setup panel>[Detailed setting]>[Camera detailed setting]>[Set]>Advanced Menu>[Easy Setup]>Clicking on the [Event action] tab displays the configuration page.



- Refer to the User manual for the event setup procedure.
- Refer to the User manual for instructions on how to configure Internet disclosure.

4.4.1 Detect the movement of the object

When an alarm is activated, the camera operates as configured. The alarm has a pattern that detects the movement of the specified area or when the camera is blocked.

- Live image page setup panel>[Detailed setting]>[Camera detailed setting]>[Display]>Advanced Menu>Clicking [Alarm] displays the configuration page.



Refer to the user manual for details of all alarms.

4.4.1.1 Set the area for detecting the movement of an object

Set the area for detecting the movement of an object using the motion detection function using video images.



- (1) (PTZ only)Select the preset position number to be set for the motion detection area and click

[Start].

- The Set Operation Detection Area screen is displayed.
- (2) Drag in the image to set the area.
- You can set the areas in order.
- (3) Adjust the [Detection area] and [Detection sensitivity] using the slider bar and then click [Set].

4.5 Enhance communication security

Setting up HTTPS encrypts camera access and enhances communication security.

- Refer to the following support video for the HTTPS setting method (Pre-installed).
→[Support video](#)
- For information about how to configure HTTPS (CA certificate), refer to the following support video.
→[Support video](#)

4.6 Detect data falsification

If you set Falsification Detection, you can detect falsified data on the SD Memory Card using the dedicated software.

Refer to the following support video for how to set up falsification detection.

→[Support video](#)

4.7 Set the resolution and frame rates

➤ Live image pages configuration panels>[Stream] tabs>Set in [Image capture mode] of [Common].



- Refer to the User Manual for details on settings and frame rates.
- For more information on resolution, see the following.
→[6.2 Image capture mode and Image capture size](#)

4.8 Set the overlay image function

You can specify the position to overlay the uploaded image or specify the color to be transmitted. In models that support SD Memory Card recording, the overlay displayed images are recorded during recording.

Refer to the User manual for details on how to configure the settings.

➤ Live image page setup panel>[Detailed setting]>[Camera detailed setting]>[Basic] in the Advanced menu on the left>Configure in the [Overlay image] tab.

- (1) Select an image with [Overlay] set to [On].
- (2) Set [Position], [Permeation], and [Selection of color to be penetrated]
- (3) Click [Set]

4.9 Set the image stream

4.9.1 About the Setting of Stream

You can configure whether to deliver streams, whether to use H.265 or H.264 compression, and what resolution, image quality, and streaming method to use.

- Live image page setup panel>Use the [Stream] tab. The streams of H.265 and H.264 images are set in [Stream] on the [Stream] tab.
- For the image compression method, refer to the following.
→[Reducing Data Capacity with Smart Coding](#)
 - Refer to the following for how to distribute.
→[About delivery volume control \(bit rate\)](#)
 - Refer to the User manual for details of each setting method.

4.9.2 About delivery volume control (bit rate)

The following types of delivery modes are used to control the amount of delivery (bit rate) of the stream, and settings are made accordingly. You can also use smart coding, such as [Smart VIQS], to reduce the amount of data. For information about controlling the amount of stream delivery, see the following. Refer to the User manual for details.

→[Reducing Data Capacity with Smart Coding](#)

- **Fixed bit rate:**

H.265 (or H.264) images are delivered at the bit rate set by [Max bit rate (per client) *].

- **Variable bit rate:**

H.265 (or H.264) images are delivered at the frame rate set by [Frame rate*] while maintaining the image quality level set by [Image quality]. At this time, the bit rate is varied within the maximum bit rate set by [Max bit rate (per client) *]. The recording capacity varies depending on the [Image quality] settings and object conditions.

- **Specify Frame Rate:**

H.265 (or H.264) images are delivered at the frame rate set by [Frame rate*].

- **Best effort delivery:**

Depending on the bandwidth of the network, H.265 (or H.264) images are delivered with varying bit rates within the maximum bit rate set by [Max bit rate (per client) *].

4.9.3 Reducing Data Capacity with Smart Coding

Smart coding is a data compression technology that minimizes compression to clearly capture a person's face, high compression to the background, and optimises compression by the object.

- Live image page setup panel > [Detailed setting] > [Camera detailed setting] > [Image] or [Image/Audio] in the Advanced menu on the left > Clicking [Image] displays the Smart Coding configuration.

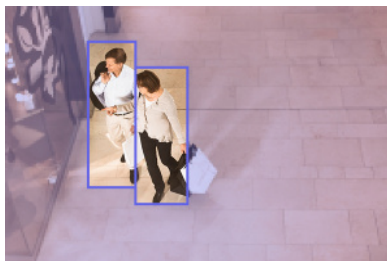

This image is for reference. It is different from the actual view of the screen.

[Smart VIQS]

The image quality of the area where the object (head, people, automobiles, and motorcycles) is displayed is maintained at high quality. Images other than objects are delivered in such a way that low or medium image quality is maintained and the amount of data is reduced.

[Smart P-picture control]

In order to reduce the amount of data, data generation (macroblock) is reduced in areas other

than where objects (head, people, automobiles, and motorcycles) are displayed.

[GOP control]

You can reduce the amount of data.

4.10 Adjust the zoom/focus

You can manually or automatically adjust the zoom or focus of the displayed image.

- You can set zoom and focus by clicking [Camera control] buttons on the live image pages.
- 1. Configure [Zoom], [Focus], and [Displays the auto focus frame] on the [Zoom] tab.
 - Zoom and focus can be adjusted. Zoom can also be adjusted with the mouse wheel operation.

4.11 Hide some of the images

- Live image page setup panel>[Detailed setting]>[Camera detailed setting]>[Image] in the Advanced menu on the left>[Privacy zone] in the [Image quality] tab>Click [Setup] to open the Privacy Zone Setting window.



- (1) Select the camera for which you want to set the privacy zone in [Camera selection].
- (2) On the image, specify four vertices of the area you want to hide and click [Set].
 - Privacy zones are set in order from Area 1.
- (3) Select [Status] to view privacy zones
 - Set up the privacy zone in [On]/[Off].

4.12 Identify sounds with AI

Image monitoring can be enhanced by identifying and detecting human cries, broken glass sounds, horns, guns, and other sounds.

- Live image page setup panel>[Detailed setting]>[Camera detailed setting]>[Display]>Advanced Menu>[Alarm]>Clicking on the [Audio detection] tab displays the configuration pages.



For more information about AI Sound Classification, see below.

→[WHITE PAPER](#)

- (1) Set [Audio detection] to [On] to set sound detection.
- (2) Select Sensitivity of Detection with [Detection sensitivity].
- (3) Select the sound to be detected by [AI analytics target].
 - Selection of [Other] is not recommended in conjunction with other sounds detected. For example, when a gun sound is detected with the settings for detecting two sounds: [Gunshot] and [Other], it is detected as two sounds.



For validated external microphones, see below.

→[Verification result of external microphones](#)

4.13 Record sound

Audio data can be recorded to SD recording when an alarm is detected.

- (1) Select whether to record audio data in the SD recording setting screen.
 - [On]: Audio data is saved in videos (MP4 format).
 - [Off]: Audio data is not saved in videos (MP4 format).

4.14 i-PRO Configuration Tool (iCT)

This is a tool for managing the image monitoring system in one place.



For more information about i-PRO Configuration Tool (iCT), see the following.

→[Click here for more information about i-PRO Configuration Tool](#)

5. Clean up



- Turn off the power before starting operation. Otherwise, it may result in injury.
- Do not apply or use organic solvents such as benzene and thinner. The enclosure may become discolored. Follow the precautionary statement when using chemical foil.
- Do not loosen or remove screws not specified in the operation manual.

5.1 Cleaning of lenses



- Clean with lens cleaning paper (for cleaning cameras and eyeglasses).
- Alcohol should be used when solvents are used. Do not use glass cleaners or thinners.

5.2 Cleaning of Dome covers



Use lens cleaning paper (used to clean camera or spectacles lenses) to remove any dirt on the dome cover. The mark of light-shielding parts left inside the dome or dirt on the dome cover may influence the reflection of infrared rays. Therefore, likewise remove those marks and dirt using cleaning paper.

6. Specifications

6.1 PC environment required

| | |
|-------------------------|--|
| CPU: | Intel®Core™ processor family Intel®Core™ i5-6500 or more Intel®Recommended at least Core™ i7-6700 |
| Memory: | Recommended at least 4 GB (2 GB x 2, dual channel) |
| Network function: | 10BASE-T/100BASE-TX/1000BASE-T 1 port |
| Sound function: | Sound Card (for voice function) |
| Image display function: | Image capture size : 1024 x 768 pixels or more High Image capture size monitoring: 3840 x 2160 pixels or more Color: 24 bits or more of True Color |
| Compatible OS: | Microsoft Windows 11 Microsoft Windows 10 |
| Web browser: | Google Chrome™ Firefox Microsoft Edge (after Chromium) |
| Other: | Adobe®Reader®Or Acrobat Reader®(For viewing PDF files) |

6.2 Image capture mode and Image capture size



- The bit rate of streams is restricted to [Bandwidth control(bit rate)] on the [Network] tabs of network pages.
- It is recommended to set the bit rate of stream to 8192kbps or less for all cameras combined. When a value larger than 8192kbps is set, there is a possibility of an abnormality occurring in continuity of recorded video.
- When the refresh interval is short, the bit rate may be exceeded depending on the object.
- Depending on the number of concurrent users or the combination of functions used, the bit rate may be lower than the set value. Confirm the image delivered

6. Specifications

6.2 Image capture mode and Image capture size

after setting.

The initial value is underlined.

| Product number/ Image capture mode | Stream (1) | Stream(2) | JPEG |
|--|------------------|------------------|------------------|
| WV-S85702-F3L | 3840x21600 | | 3840x2160 |
| " <u>8 megapixels [16:9] (15 fps mode)</u> " | 2560x1440 | | 2560x1440 |
| " <u>8 megapixels [16:9] (12.5 fps mode)</u> " | <u>1920x1080</u> | | 1920x1080 |
| "8 megapixels [16:9] (15 fps Dual mode)"*2 | | 1280x720 | 1280x720 |
| | | <u>640x360</u> | <u>640x360</u> |
| "8 megapixels [16:9] (12.5 fps Dual mode)"*2 | | 320x180*1 | 320x180*1 |
| | Max 15(12.5) fps | Max 15(12.5) fps | Max 5(5) fps*3*4 |
| WV-S85402-V2L/WV-U85402-V2L | 2688x1520 | | 2688x1520 |
| " <u>4 megapixels [16:9] (30 fps mode)</u> " | 2560x1440 | | 2560x1440 |
| " <u>4 megapixels [16:9] (25fps mode)</u> " | <u>1920x1080</u> | | 1920x1080 |
| "4 megapixels [16:9] (30 fps Dual mode)"*2 | | | 1280x720 |
| | | <u>640x360</u> | <u>640x360</u> |
| "4 megapixels [16:9] (25 fps Dual mode)"*2 | | 320x180*1 | 320x180*1 |
| | Max 30(25) fps | Max 30(25) fps | Max 5(5) fps*3*4 |

*1 When "320x180" is selected for "Image capture size", the "90 °" or "270 °" cannot be set for [Image rotation].

*2 Dual mode is not supported by 320 x 180.

*3 When Image capture size is 3840 x 2160 and 2688 x 1520, the refresh interval is limited to 1 fps max. and when Image capture size is 2560 x 1440, the refresh interval is limited to 2 fps max. (2.1 fps).

*4 When both Stream (1) and Stream (2) are Off, the maximum refresh interval for WV-S85702-F3L is 15fps (12.5fps), and the maximum refresh interval for WV-S85402-V2L/WV-U85402-V2L is 30fps (25fps).

6.2.1 Restrictions

• If any of the following conditions apply, [Image Rotation] cannot be set to "90 °" or "270 °". Refer to the User Manual for details.

- When the extension software is installed
- When [Intelligent Auto] is set to "On"

6. Specifications

6.5 About the Function Extension Software Available

- When any item of [Smart Coding] is set to "On"

6.3 DORI

| | WV-S85702-F3L | WV-S85402-V2L/WV-U85402-V2L | |
|----------------------------|---------------|-----------------------------|----------|
| | | WIDE | TELE |
| Detect (25 ppm/8 ppf) | 56.8 m | 45.1 m | 147.7 m |
| | 186.4 ft | 148.0 ft | 484.6 ft |
| Observe (62.5 ppm/19 ppf) | 22.7 m | 18.0 m | 59.1 m |
| | 74.6 ft | 59.2 ft | 193.8 ft |
| Recognize (125 ppm/38 ppf) | 11.4 m | 9.0 m | 29.5 m |
| | 37.3 ft | 29.6 ft | 96.9 ft |
| Identify (250 ppm/76 ppf) | 5.7 m | 4.5 m | 14.8 m |
| | 18.6 ft | 14.8 ft | 48.5 ft |

6.4 Delivery performance

- Up to 24 users are accessible at the same time.
- The maximum bandwidth is 200 Mbps.

6.5 About the Function Extension Software Available

This is information about the number of pre-installed extended software and their capacities.

| Number of applications installed | App capacity (ROM capacity) | App capacity (RAM capacity) |
|----------------------------------|-----------------------------|-----------------------------|
| 4 | 150 MB | 250 MB |



For information on the latest software and restrictions during use, refer to the

Technical information website(C0103).

→[Technical information website](#)

6. Specifications
 6.6 Lamp

| Application name | Pre-installed | Support status |
|---------------------------|---------------|----------------|
| AI-VMD | Yes | Supported |
| AI Privacy Guard | No | Not supported |
| AI Face Detection | No | Supported |
| AI People Detection | No | Supported |
| AI Vehicle Detection | No | Supported |
| AI Non-Mask Detection | No | Supported |
| AI Occupancy Detection | No | Supported |
| AI Scene Change Detection | No | Supported |

6.6 Lamp

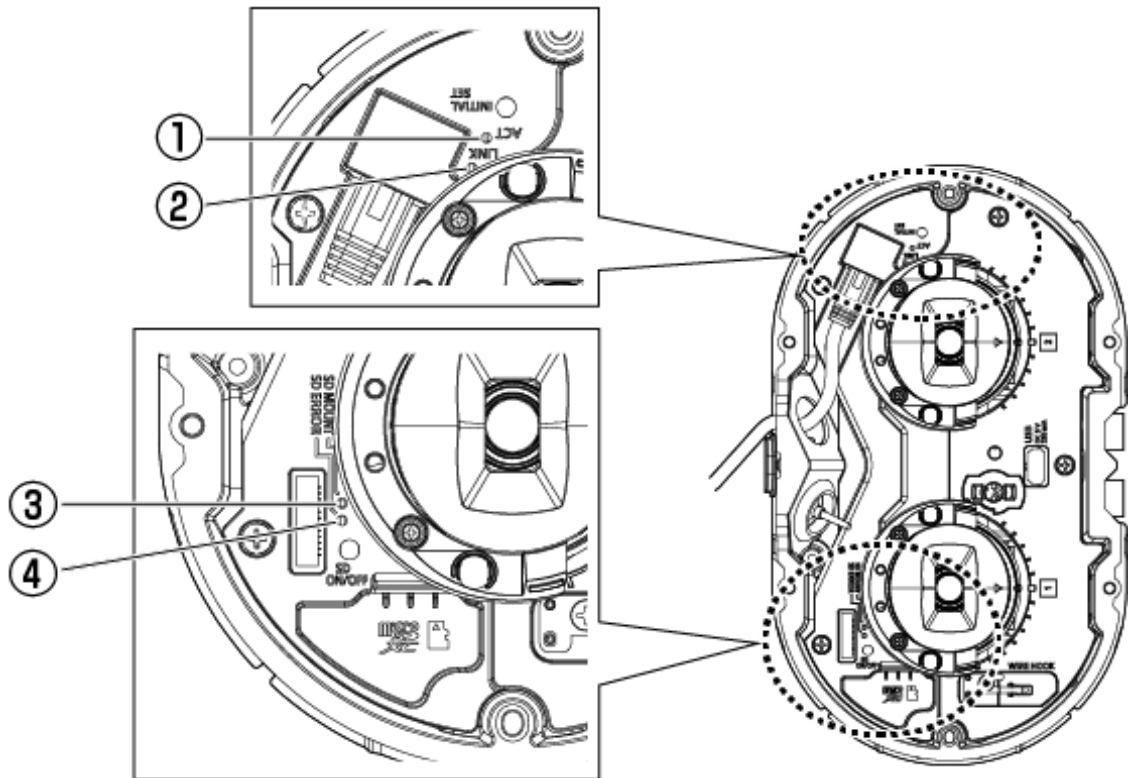

- ① ACT lamp
- ② LINK lamp
- ③ SD MOUNT lamp
- ④ SD ERROR lamp<WV-S85702-F3L>
 SD ERROR/AF lamp<WV-S85402-V2L><WV-U85402-V2L>

6.6.1 Lighting of the lamp

LINK lamp

When communication with connected devices becomes possible

- Orange LED is ON

ACT lamp

When the computer is sending and receiving data

- Green LED is flashing (accessed)

SD ERROR lamp<WV-S85702-F3L>

- Machine is running
 - Red ON
- When the SD Memory Card is successfully recognized
 - Red LED is ON → OFF
- If the SD slot is not used or an SD Memory Card error is detected after startup
 - Red ON

SD ERROR/AF lamp<WV-S85402-V2L><WV-U85402-V2L>

- Machine is running
 - Red ON
- When the SD Memory Card is successfully recognized
 - Red LED is ON → OFF
- If the SD slot is not used or an SD Memory Card error is detected after startup
 - Red ON
- When the auto focus function is used
 - Red LED is flashing (Turns off when focus adjustment is completed).

SD MOUNT lamp

- When “Not use” is selected for SD memory card, or an error occurred for the SD memory card
 - Goes off
- When the SD memory card is being recognized or is performing the necessary processing for the SD memory card to be removed
 - Green LED is flashing
- When data can be saved to the SD memory card
 - Green ON



For more information about lamps, refer to the User manual.

6.7 Button

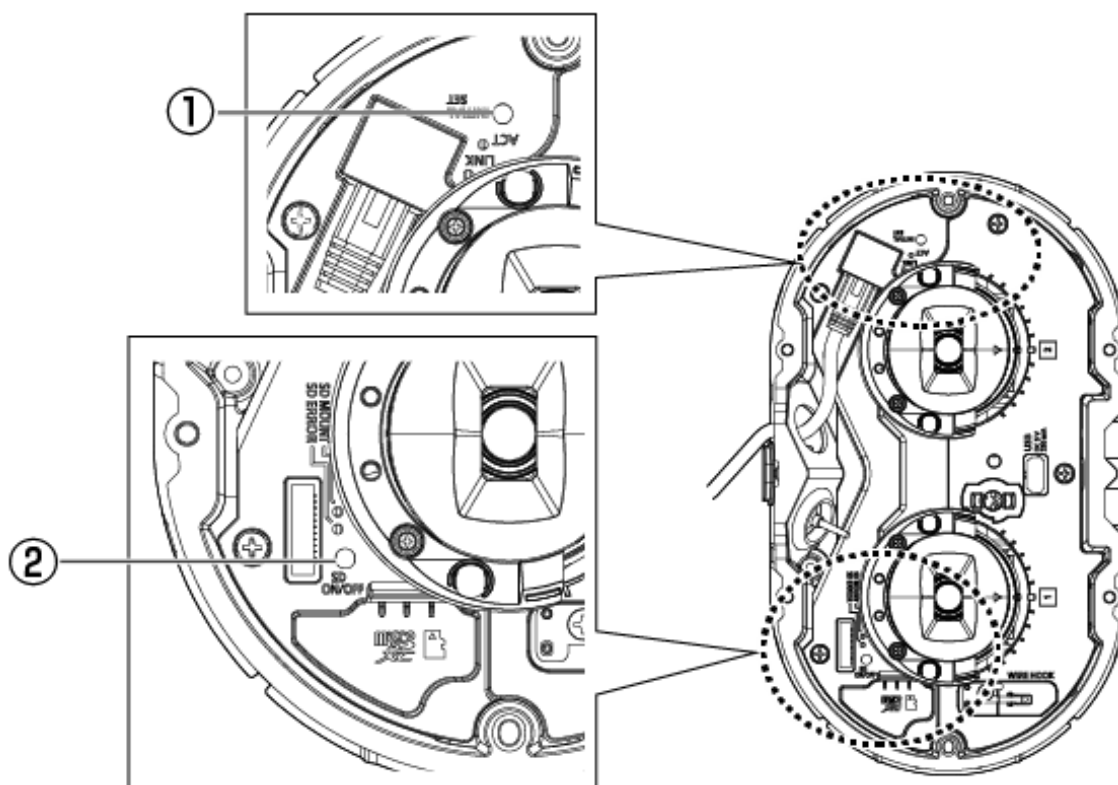

① INITIAL SET button

② SD ON/OFF button

6.8 Cable

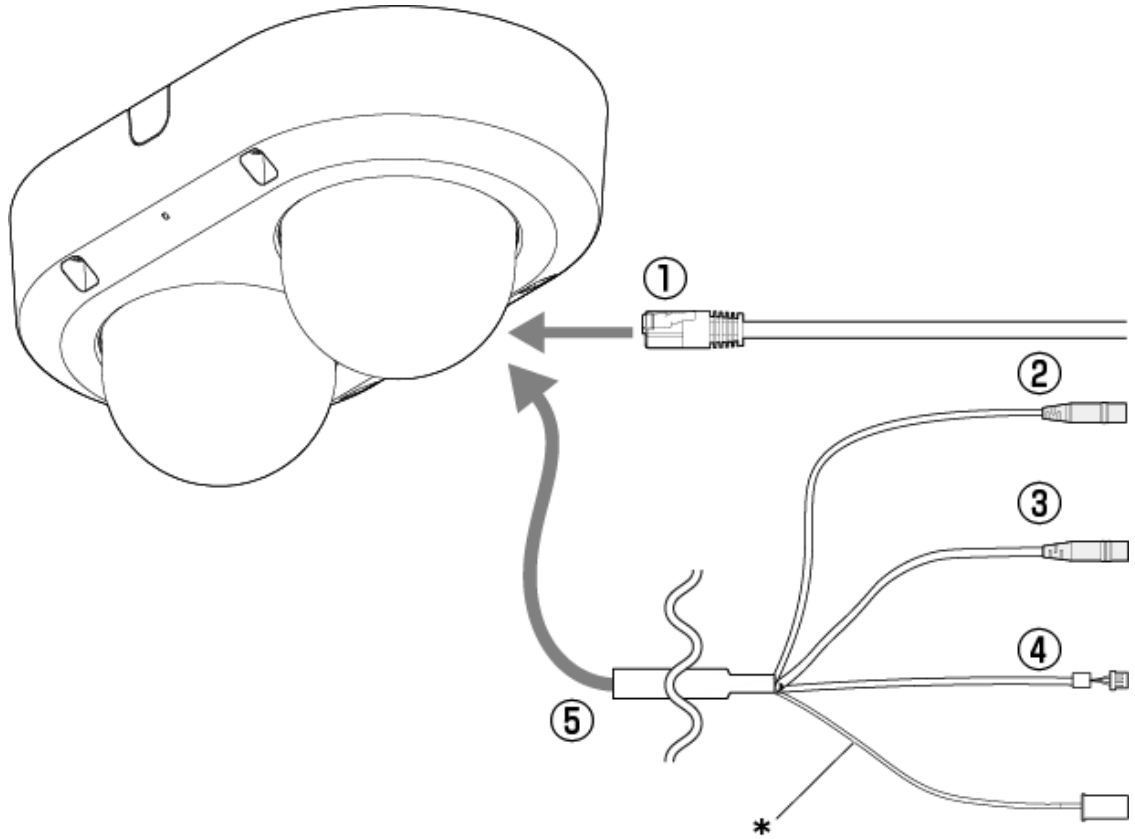

* This cable is not used. Waterproof it with the other cables.

- ① RJ45 network cable
- ② Audio input cable (white)
- ③ Audio output cable (black)
- ④ External I/O cable
- ⑤ I/O Cable (optional)

6.9 MicroSD memory card slot

Insert the microSD memory card into the microSD slot.

6. Specifications

6.9 MicroSD memory card slot

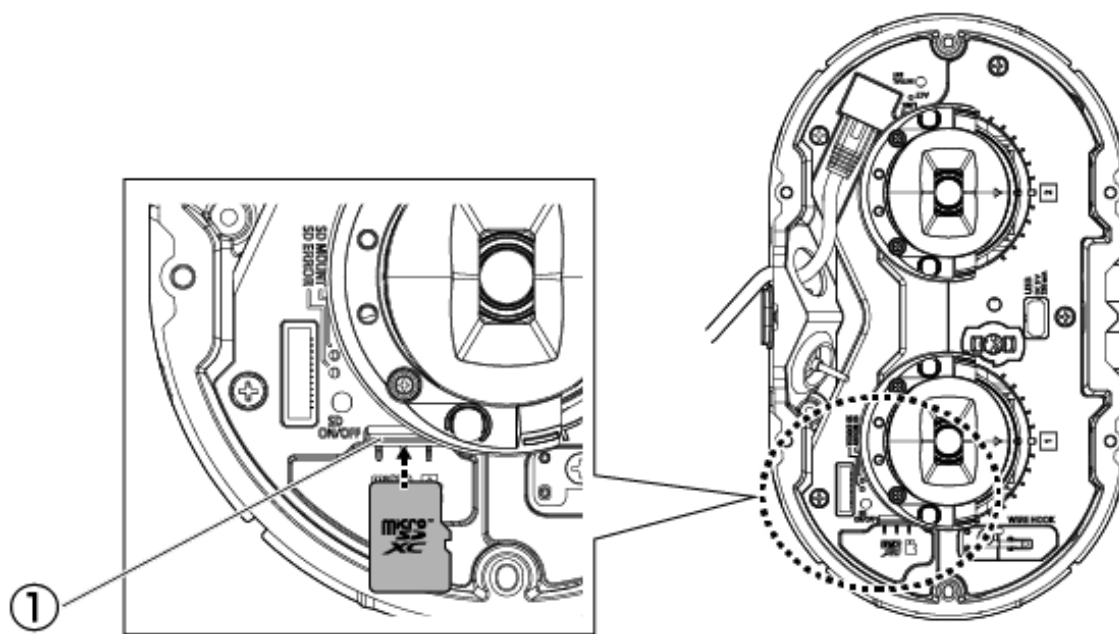

① MicroSD slot

7. Other

7.1 Initialize

Click the INITIAL SET button to initialize the main unit. See below for the position of the INITIAL SET button.

→[6.7 Button](#)

- (1) Disconnect the Ethernet cable from the computer and turn off the computer.
- (2) Turn on the computer while pressing the [INITIAL SET] button.
- (3) [INITIAL SET] button holds pressing for 15 seconds or more after power is turned on
- (4) Release the [INITIAL SET] button
 - Approximately two minutes later, the computer is started and the settings containing the network settings are initialized. If it does not start normally, try again.

7.2 Check the software version

The functions of this machine are implemented in software. We recommend that you first check the current software version if there is a problem with the operation of the computer.

➤ Clicking on the Live image pages Settings panels > [Detailed setting] > [Camera detailed setting] > [Maintenance] > [Upgrade] tabs in the Advanced menus to the left will bring up a window with versions.

- (1) Check software versions with [Firmware version]
 - You can check the current software version.



Up-to-date versions of software may contain modifications to specific problems.

7.3 Upgrade software

➤ Clicking on the Live image pages Settings panels > [Detailed setting] > [Camera detailed setting] > Advanced menu [Maintenance] > [Upgrade] tab on the left will bring up the software–upgrade window. The available screen is displayed.

- (1) Download the latest software to the PC
- (2) Click Select Files to specify the software you downloaded, and then click [Execute].



- Use a PC on the same subnet as the machine to upgrade the version.
- Do not turn off the computer during version upgrading. Do not perform any operation until the version upgrade is completed.
- Be sure to check the version after upgrading. Also, delete the temporary Internet file.

7.4 Order of setting when adjusting image quality

It is recommended to set the settings for image quality in the following order: Adjustment of visibility → Adjustment of color → Removal of noise.

- (1) Adjust the visibility
 - [Light control mode], [Intelligent Auto], [Super Dynamic], [Contrast level], [High light compensation(HLC)], [Adaptive black stretch], [Adaptive highlight stretch], [Maximum gain], [Maximum shutter], [pedestal level]
- (2) Adjust the color
 - [White balance], [Chroma gain level]
- (3) Remove the noise
 - [Digital noise reduction], [Sharpness level]



Refer to the User manual for details of each function.



- The image quality adjustment function may affect each other.
- If necessary, adjust the brightness level of the screen.

7. Other

7.6 Adjust the brightness of the object (dark scenes)

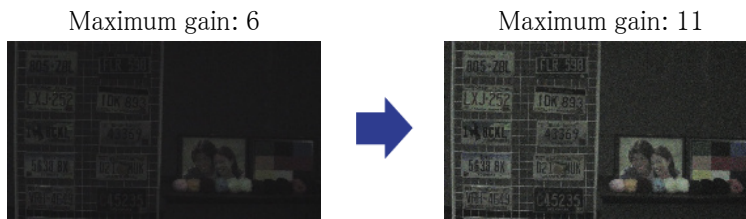

- Increasing the maximum gain increases noise.
- [Image quality] in Live image pages > [Maximum gain] cannot be set when [Common(Cam. 1-2)] is selected in [Camera selection]. To configure [Maximum gain], select anything other than [Common(Cam. 1-2)].

7.6.2 Adjust the maximum exposure time

Increasing the maximum exposure time brightens the image.

- Live image page setup panel > Clicking the [Image quality] tab enables you to set the image quality.
- (1) Select [Maximum shutter] of [Light control mode]
 - Selecting [Maximum shutter] longer than [Max. 1/30s] brightens the image because the amount of light entering increases.



- Increasing the maximum exposure time increases the blur.
- [Image quality] in live image pages > [Maximum shutter] cannot be set when [Common(Cam. 1-2)] is selected in [Camera selection]. To configure [Maximum shutter], select anything other than [Common(Cam. 1-2)].

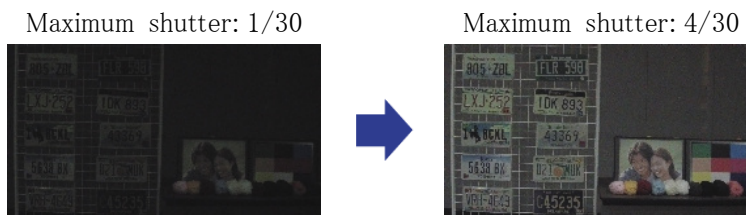

7.7 Reduce white flickering and blacking on the screen

7.7.1 Set Super Dynamic

When Super Dynamic is set to ON, both bright and dark areas are reproduced faithfully, even when shooting in a place with a large brightness difference.

➤ Live image page setup panel>Clicking the [Image quality] tab enables you to set the image quality.

(1) Set [Super Dynamic] to [On]



Set [Super Dynamic] to [Off] when the following phenomena are observed depending on the lighting condition.

- If flicker or color change occurs
- Noise in bright areas on the screen

Super Dynamic: Off



Superdynamic:

On-crf-Level: 28



7.7.2 Set the back light compensation

Setting [Back light compensation] prevents black clipping of the object indoors in an outdoor environment where strong light enters (brightens the object indoors).

➤ Live image page setup panel>[Detailed setting]>[Camera detailed setting]>[Image] or [Image/Audio] in the Advanced menu on the left>[Image adjust] in the [Image quality] tab>Click [Setup] to display the image quality adjustment setting screen.

(1) Set to [Back light compensation(BLC)] in the [Super Dynamic] [BLC/ HLC]

7. Other

7.7 Reduce white flickering and blacking on the screen



If [Super Dynamic] is set to [On] or [Intelligent Auto] is set to [On], [Backlight Compensation] cannot be set.

Back light compensation:
Off



Back light compensation:
On
Level: 16



7.7.3 Set the high light compensation

By setting [High light compensation(HLC)], bright lights, such as car headlights, suppress the brightness of the object.

- Live image page setup panel>[Detailed setting]>[Camera detailed setting]>[Image] or [Image/Audio] in the Advanced menu on the left>[Image adjust] in the [Image quality] tab> Click [Setup] to display the image quality adjustment setting screen.

- (1) Select [High light compensation(HLC)] in [Super Dynamic] [BLC/ HLC]



If [Super Dynamic] is set to [On] or [Intelligent Auto] is set to [On], it cannot be set to [High light compensation(HLC)].

High light Compensation:
Off



High light Compensation:
On
Level: 31



7.7.4 Adjust the adaptive black stretch

Adjust the [Adaptive black stretch] to brighten the dark areas of the images.

- Live image page setup panel>[Detailed setting]>[Camera detailed setting]>[Image] or [Image/Audio] in the Advanced menu on the left>[Image adjust] in the [Image quality] tab> Click [Setup] to display the image quality adjustment setting screen.

- (1) Adjust [Detailed setting] [Adaptive black stretch] level to [+]

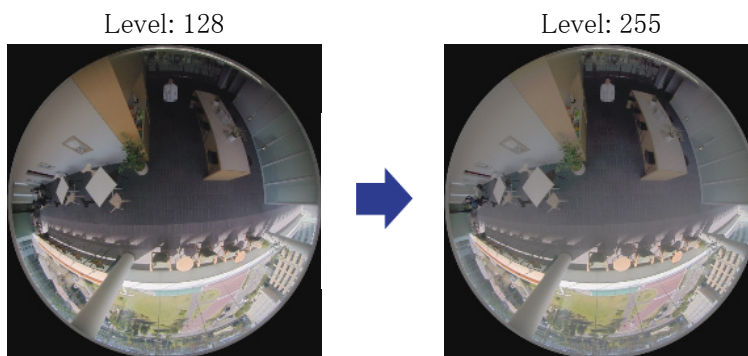

7.7.5 Adjust the [Pedestal level]

Adjust the [Pedestal level] to adjust the black level of the image.

- Live image page setup panel>[Detailed setting]>[Camera detailed setting]>[Image] or [Image/Audio] in the Advanced menu on the left>[Image adjust] in the [Image quality] tab> Click [Setup] to display the image quality adjustment setting screen.

- (1) Adjust the [Pedestal level] of the [Detailed setting].

- Moving in the [+] direction brightens the image.
- Moving in the [-] direction darkens the image.

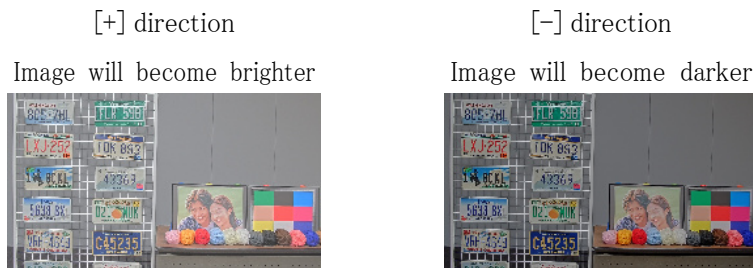

7.8 Adjust the contrast of the object

7.8.1 Adjust the contrast

By adjusting the [Contrast level] and increasing the contrast of the images, you can improve the visibility of the object with less contrast.

- Live image page setup panel>[Detailed setting]>[Camera detailed setting]>[Image] or [Image/Audio] in the Advanced menu on the left>[Image adjust] in the [Image quality] tab> Click [Setup] to display the image quality adjustment setting screen.

- (1) Adjust [Detailed setting] [Contrast level] levels to [+]

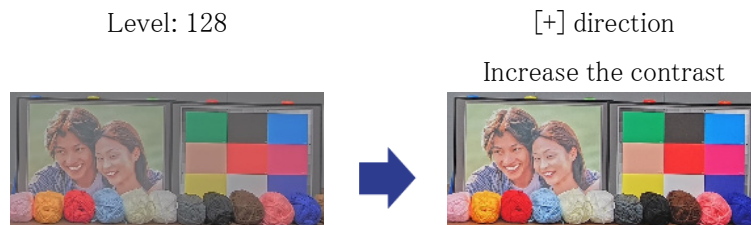

7.9 Reduce flicker

Flickering is automatically corrected by using [Light control mode].

- Live image page setup panel>Clicking the [Image quality] tab enables you to set the image quality.

- (1) Select [Flickless (50 Hz)] or [Flickless (60 Hz)] for [Light control mode].
 - Use 50 Hz/60 Hz depending on the region.

7.10 Reduce the blur of an object (bright scene)

7.10.1 Set intelligent auto (motion priority level)

By using [Intelligent Auto], the camera identifies objects with movement such as scenes

7. Other

7.10 Reduce the blur of an object (bright scene)

(backlights, outdoors, night scenes, etc.) and faces of people. The camera automatically adjusts the amount, gain, shutter speed, and contrast of light entering the camera from the lens to make it easier to view moving objects.

- Live image page setup panel>[Detailed setting]>[Camera detailed setting]>[Image] or [Image/Audio] in the Advanced menu on the left>[Image adjust] in the [Image quality] tab> Click [Setup] to display the image quality adjustment setting screen.
- (1) Adjust [Face priority level (Brightness)] and [Motion priority level (Shutter)] with [Intelligent Auto] set to [On].
 - By adjusting in the [+] direction, blurring of the object is reduced.



Increasing the level in a low illumination environment increases noise.

Off (person
blurred)



On (less blurring)

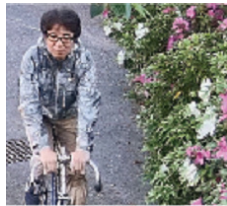

7.10.2 Adjust the maximum exposure time

Reducing the maximum exposure time reduces blurs.

- Live image page setup panel>Clicking the [Image quality] tab enables you to set the image quality.
- (1) Select a [Light control mode] [Maximum shutter] shorter than [1/30 (default)].
 - If [Maximum shutter] is set to a shorter time than [1/30 (default)], blurs will be reduced.



In low illumination environments, the object becomes dark and noise increases when the maximum exposure time is shortened.

7. Other

7.11 Redue the blur of an object (dark scene)

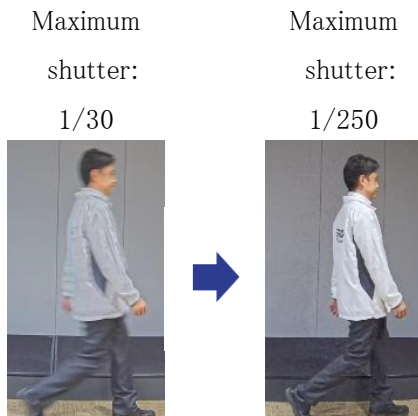

7.11 Redue the blur of an object (dark scene)

7.11.1 Adjust digital noise reduction

Reducing the effects of noise reduction by adjusting the [Digital noise reduction] reduces blurs.

➤ Live image page setup panel>Clicking the [Image quality] tab enables you to set the image quality.

(1) Adjust the [Digital noise reduction] in the [-] direction.



•If the effect of noise reduction is reduced, the noise will increase.

•[Image quality] in the multi part live image page>[Digital noise reduction] cannot be set when [Common(Cam. 1-2)] is selected in [Camera selection]. To configure [Digital noise reduction], select anything other than [Common(Cam. 1-2)].

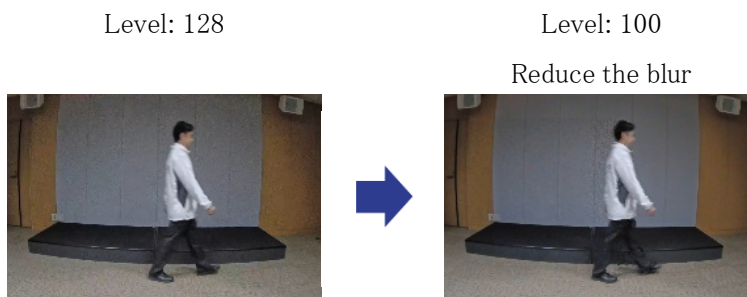

7. Other

7.14 Reduce object noise (bright scene)

7.13.2 Adjust the white balance

If the color is affected by a sodium lamp, use [White balance] to adjust the color.

- Live image page setup panel>[Detailed setting]>[Camera detailed setting]>[Image] or [Image/Audio] in the Advanced menu on the left>[Image adjust] in the [Image quality] tab> Click [Setup] to display the image quality adjustment setting screen.

(1) Select [ATW2] in [White balance]

- The camera automatically adjusts the white balance under a sodium lamp.

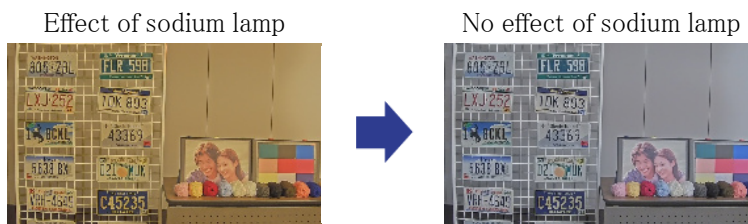

7.14 Reduce object noise (bright scene)

7.14.1 Adjust the sharpness level

Adjusting the [Sharpness level] to make the images soft reduces the noise around the object.

- Live image page setup panel>Clicking the [Image quality] tab enables you to set the image quality.

(1) Adjust the [Sharpness level] in the [-] direction.

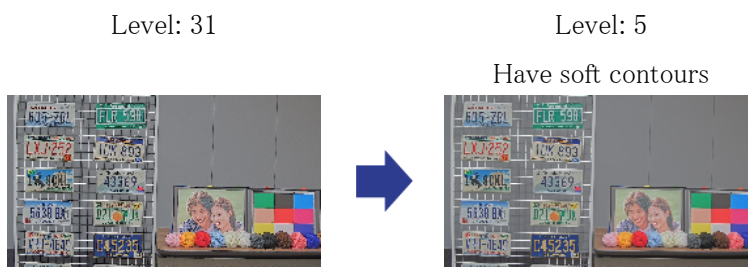

7.15 Reduce object noise (dark scene)

7.15.1 Adjust digital noise reduction

By adjusting the [Digital noise reduction] and increasing the effects of noise reduction, noise is reduced.

➤ Live image page setup panel>Clicking the [Image quality] tab enables you to set the image quality.

(1) Adjust the [Digital noise reduction] to [+]



Increasing the effect of noise reduction increases blurs.

Level: 90



Level: 255

Reduce noise



7.16 Set focus when switching between the color mode and the black & white mode.

7.16.1 Focus adjustment method upon switching between the color mode and the black & white mode

If spots such as street lights or flat object are reflected in low-illumination conditions, the focus may not match when switching between black and white. If this is the case, adjust the focus as shown below.

➤ Live image pages configuration panels>[Detailed setting]>[Camera detailed setting]

[Advanced settings page]>[Image/Audio] of the Advanced menus on the left>[Zoom/focus adjustment] in the [Image quality] tabs>To Advanced Settings>>Click [Zoom/Focus Adjustment] to open the zoom/focus setting screen.

1. Change [Focusing at Day & Night switching] to [Preset].
2. Execute [Manual focus adjustment] or [Auto focus] in color mode.
 - The focus position is stored in the color mode during daytime shooting.
3. Execute [Manual focus adjustment] or [Auto focus] in black & white mode.
 - The focus position is stored in black and white during night shooting.

➤ Live image pages configuration panels>[Detailed setting]>[Camera detailed setting] [Advanced settings page]>[Image/Audio] of the Advanced menus on the left>[Image adjust] in the [Image quality] tabs>To Advanced Settings>>Click [Image Quality Adjustment] to display the image quality adjustment setting screen.

4. Set [Day & Night(IR)] to [Auto1(IR Light Off)], [Auto2(IR Light On)], or [Auto3(SCC)] depending on the application.



To be black & white mode during the daytime, set [Day & Night(IR)] to [On(IR Light On)] to force black & white mode.

Zoom/focus adjustment

| | |
|---|---|
| Zoom/focus adjustment | Cam. 1 |
| Zoom ratio designation | <input type="range"/> x1.0 Execute |
| Manual zoom adjustment | <input type="button" value="Q"/> <input type="button" value="Q"/> <input type="button" value="Q"/> |
| Manual focus adjustment | <input type="button" value="Near"/> <input type="button" value="Reset"/> <input type="button" value="Far"/> |
| Focus area setting | <input type="button" value="Display"/> |
| Auto focus | <input type="button" value="Execute"/> |
| Focusing at Day & Night switching | Auto |
| Grid display | <input type="checkbox"/> <input type="checkbox"/> |
| <input type="button" value="Set"/> <input type="button" value="Close"/> | |

Image quality adjustment

| | |
|---|---|
| Common(Cam. 1-2) Scene file is not applied | |
| Basic adjustment | |
| Super Dynamic(SD) | <input checked="" type="radio"/> On <input type="radio"/> Off |
| Light control mode | ELC |
| +Day & Night(IR) | Auto2(IR Light On) |
| White balance | ATW1 <input type="button" value="Set"/> |
| Intelligent Auto | <input checked="" type="radio"/> On <input type="radio"/> Off |
| +Scene registration | |
| *Any changes are updated immediately | |
| *Adjust the detail setting individually in the menu of each camera. | |
| <input type="button" value="Close"/> | |

7.17 Troubleshooting

Check the issues on this table before asking for repair.

Contact the dealer from whom you purchased if you do not recover from any of these problems or if you have issues other than those listed in this table.

7. Other
7.17 Troubleshooting

| Phenomenon | Cause | Countermeasures | Reference |
|---------------------------------------|---|---|--|
| Does not power on | <ul style="list-style-type: none"> •Does the PoE+ (IEEE 802.3at compliant) power supply and Ethernet cable of this equipment connect? •Some power supply devices that can connect multiple PoE+ terminal devices will not supply power if the total power supply exceeds the limit. | <ul style="list-style-type: none"> •Check if it is connected. •Refer to the instruction manual for the PoE+ power supply. | Operation Manual Installation Guide |
| Cannot be accessed from a Web browser | •Are cables of category 5e or higher connected to the network connector? | •Connect a cable with Category 5e or higher. | Operation Manual Installation Guide |
| | •Is the link lamp (LINK) illuminated? If the LED is not illuminated, the LAN is not connected correctly or the host network is not operating normally. | •Check the cable for faulty contact and wiring. | Operation Manual Installation Guide |
| | •Is this unit turned on? | •Check this unit is turned on. | Operation Manual Installation Guide |
| | •Are valid IP addresses set for your computer? | •Check whether the IP address is valid. | User Manual |

| | | | |
|--|--|--|--|
| | <ul style="list-style-type: none">•Have you accessed the wrong IP address? | <ul style="list-style-type: none">•Confirm the connection using the following method. At the Windows command prompt, enter the following. >Ping "IP address set for the computer" If Reply is returned from the computer after input, it is operating normally. If Reply is not returned, check the connection using the PC connected to the same network as the camera using the following method. If the firewall setting of the PC is enabled, temporarily cancel the firewall setting before setting the camera.•Start the IP Easy Configuration Software, check the camera IP address, and access the IP address. | |
|--|--|--|--|

| | | |
|---|--|-------------|
| | <ul style="list-style-type: none"> •If the network settings (IP address, subnet mask, and default gateway) are incorrect, restart the camera and change the network settings using the IP Setting Software within 20 minutes. •In an environment without a DHCP server, restart this unit with the Initialize button and initialize it. The IP address is set to 192.168.0.10. Then access this unit to reset the IP address (which initializes all settings). | |
| <ul style="list-style-type: none"> •Is 554 configured for the HTTP port number? | <ul style="list-style-type: none"> •Use ports other than 20, 21, 22, 23, 25, 42, 53, 67, 68, 69, 110, 123, 161, 162, 443, 554, 995, 1883, 883, 10689, 10670, 59000–61000. | User Manual |
| <ul style="list-style-type: none"> •Is the set IP address overlapping with other devices? Is there a conflict between the configured address and the destination network subnet? | <ul style="list-style-type: none"> •Check the set IP address. | – |

| | | | |
|---|---|---|-------------|
| | <p>When this unit and the computer are connected in the same subnet</p> <ul style="list-style-type: none"> •Are the IP addresses of this unit and the PC set to the same subnet? Also, is "Using a Proxy Server" set on the PC? | <ul style="list-style-type: none"> •When accessing this unit within the same subnet, it is recommended that the address of this unit be set to "Remove from proxy". | |
| | <p>When this unit and the PC are connected to different subnets</p> <ul style="list-style-type: none"> •Is the default gateway set to this unit incorrectly? | <ul style="list-style-type: none"> •Check the default gateway values. | |
| | <ul style="list-style-type: none"> •Have you accessed the HTTPS function with "http://"? | <ul style="list-style-type: none"> •To use HTTPS, refer to https://. You must also enter the port number. | User Manual |
| Camera cannot be accessed from the Internet | <ul style="list-style-type: none"> •Are the network settings for this unit incorrect? | <ul style="list-style-type: none"> •Configure the default gateway or DNS server address correctly. When using the DDNS service, make sure that it is set correctly. | User Manual |
| | <ul style="list-style-type: none"> •Is [Default gateway] set or is it set correctly? | <ul style="list-style-type: none"> •Set the [Default gateway] correctly. <p>For IPv4</p> <ul style="list-style-type: none"> •Configure [Default gateway] correctly for [Set]-[Network]-[IPv4 network]. | |

| | |
|--|--|
| <ul style="list-style-type: none"> •Does the router have port forwarding? | <ul style="list-style-type: none"> •If your router does not have the UPnP feature, you must configure port forwarding to allow access to this unit from the Internet. Refer to your router's Instruction Manual for how to configure. |
| <ul style="list-style-type: none"> •Is the UPnP feature on the router disabled? | <ul style="list-style-type: none"> •Enable the UPnP function by referring to your router's instruction manual. |
| <ul style="list-style-type: none"> •Does the router have packet filtering, etc. to prohibit access from the Internet? | <ul style="list-style-type: none"> •Configure your router to be accessible via the Internet. Refer to your router's instruction manual for how to configure this function. |
| <ul style="list-style-type: none"> •Is it accessed by the IP address (local address) used on the local network? | <ul style="list-style-type: none"> •Confirm the IPv4 network settings, IPv6 network settings, and DDNS settings, and access the global address (or URL registered with the DDNS service) as the IP address of this unit for use on the Internet with this unit's port number. |

| | | | |
|---|---|---|-------------|
| The authentication screen is displayed continuously | <ul style="list-style-type: none"> •Has the username or password been changed? | <ul style="list-style-type: none"> •If you change the user name or password of a logged-in user in another Web browser while accessing this unit, the authentication screen is displayed each time the screen is switched. Close the Web browser and access this unit again. | User Manual |
| | <ul style="list-style-type: none"> •Have you changed the [Authentication method] settings? | <ul style="list-style-type: none"> •If you change the [Authentication method] setting, close the Web browser and re-access the Web browser. | |
| Take longer to display | <ul style="list-style-type: none"> •Have you accessed this unit on the same local network via proxy? | <ul style="list-style-type: none"> •Configure the PC so that it does not go through the proxy. | - |
| | <ul style="list-style-type: none"> •Are multiple users referring to camera images at the same time? | <ul style="list-style-type: none"> •If multiple users refer to a camera image at the same time, it may take a long time to display the screen or the camera image may be refreshed slowly. | |
| Camera cannot be | Case of a mobile device | | User Manual |

| | | | |
|---|--|---|--|
| accessed from mobile or tablet terminal | <ul style="list-style-type: none"> •URL is wrong. Or, is "/cam" not entered at the end of the URL? | <ul style="list-style-type: none"> •Check that the URL is entered correctly. When accessing this unit from a mobile device, it is necessary to enter "/cam" at the end of the URL used when accessing this unit from the PC. | |
| | <p>For a tablet terminal</p> <ul style="list-style-type: none"> •Is the URL wrong? | <ul style="list-style-type: none"> •Check that the URL is entered correctly. | |
| | <ul style="list-style-type: none"> •Is the SSL encryption method of the HTTPS of the mobile device or tablet device different from that of this unit? | <ul style="list-style-type: none"> •Set the HTTPS [Connection] to [HTTP] to re-access the HTTPS. | |
| | <ul style="list-style-type: none"> •Have you accessed the HTTPS function with "http://"? | <ul style="list-style-type: none"> •To use HTTPS, refer to https://. You must also enter the port number. | |
| | <ul style="list-style-type: none"> •About SOFTBANK Mobile's mobile devices | <ul style="list-style-type: none"> •SOFTBANK Mobile devices are prohibited from being accessed from other than Port 80, so they can only be used for cameras set as Port 80. | |

7. Other
7.17 Troubleshooting

| | | | |
|---|--|--|-------------|
| No image | <ul style="list-style-type: none"> Your mobile/tablet terminal does not support 320 x 240 pixels or 640 x 480 pixels of resolution. Or, is the size of image data that can be displayed by a mobile device or a tablet device exceeded? | <ul style="list-style-type: none"> Refer to the instruction manual for your mobile device and tablet device for the limitations on the image data size that can be displayed on the mobile device or tablet device. | – |
| Image is blurry | <ul style="list-style-type: none"> Is the focus correctly adjusted? | <ul style="list-style-type: none"> Check the focus adjustment. | User Manual |
| The camera is not focused immediately after the power is turned on. | <ul style="list-style-type: none"> Focus and ZOOM are adjusted after starting the camera, and the camera is not focused for a certain period of time. | <ul style="list-style-type: none"> The camera is not focused for a certain period of time. Wait for a while for the camera to focus. | – |
| Image is not updated | <ul style="list-style-type: none"> Depending on the web browser or version, images may not be updated or other problems may occur. | – | User Manual |
| | <ul style="list-style-type: none"> Images may stop being displayed due to network congestion or concentration of access to this unit. | <ul style="list-style-type: none"> Request the acquisition of images by pressing the [F5] key on the PC keyboard. | – |
| The camera image is not displayed (dark). | <ul style="list-style-type: none"> Is the [Brightness] set to darken? | <ul style="list-style-type: none"> Press the brightness [Normal] button. | User Manual |

7. Other
7.17 Troubleshooting

| | | | |
|---|---|--|-------------|
| Image is whitish | <ul style="list-style-type: none"> •Is the [Brightness] set to brighten? | <ul style="list-style-type: none"> •Press the brightness [Normal] button. Move the [Adaptive black stretch] slider bar in the [-] direction to darken the dark area of the image. | User Manual |
| Image flickers | <ul style="list-style-type: none"> •If flickering is a concern, set [Light control mode] to [Indoor scene]. | - | User Manual |
| Image not saved on SD Memory Card | <ul style="list-style-type: none"> •Is the SD Memory Card mounted correctly? | <ul style="list-style-type: none"> •Check that it is mounted correctly. | User Manual |
| Failure to write to or read from SD Memory Card | <ul style="list-style-type: none"> •Is the SD Memory Card formatted? | <ul style="list-style-type: none"> •Format the SD Memory Card. | User Manual |
| (SD Memory Card compatible models only) | <ul style="list-style-type: none"> •Is [----- MB] displayed on the [Remaining capacity] in the [SD memory card] tab? | <ul style="list-style-type: none"> •Format the SD Memory Card. | |
| | <ul style="list-style-type: none"> •Is [####MB/####MB] displayed on the [Remaining capacity] in the [SDmemory card] tab? | <ul style="list-style-type: none"> •Check the password lock setting. | |
| | <ul style="list-style-type: none"> •If you are using the mail notification or TCP alarm notification [Diag.] function, have you received recognition errors for SD Memory Cards? | <ul style="list-style-type: none"> •Format the SD Memory Card. | |

7. Other

7.17 Troubleshooting

| | | | |
|--|---|---|--|
| | <ul style="list-style-type: none"> •In the [Maintenance]-[Status]-[SD memory card] logs<SD>Is the [Recognition error] displayed? | <ul style="list-style-type: none"> •Format the SD Memory Card. | |
| | <ul style="list-style-type: none"> •Is the SD memory card malfunctioning? | <ul style="list-style-type: none"> •The SD Memory Card has a limited number of rewrites. Replace the SD Memory Card with a new one if it is rewritten frequently because it may have reached its service life. | - |
| Cannot transmit voice (Only for voice supported models) | <ul style="list-style-type: none"> •Are the microphone and speakers connected correctly? | <ul style="list-style-type: none"> •Check that the connection is correct. Voice transmission can only be used when connected with HTTPS. | Operation Manual Installation Guide |
| No audio from our network disk recorder or PC software package (Only for voice supported models) | <ul style="list-style-type: none"> •Some of our network disk recorders and PC software packages do not support [G.711]. | <ul style="list-style-type: none"> •Set the receiving audio compression method to [G.726 (32 kbps)] or [AAC-LC]. | User Manual |
| The image on the live image page is not displayed. | <ul style="list-style-type: none"> •Press the [F5] key on the PC keyboard or press the [Live] button. | - | User Manual |
| The shortcut icon for the camera is not displayed on the [Network]. | <ul style="list-style-type: none"> •Do you have additional Windows components for UPnP? | <ul style="list-style-type: none"> •Add the UPnP Windows component to your PC. | User Manual |

| | | | |
|---|--|--|---|
| Image not refreshed or displayed successfully | <ul style="list-style-type: none"> The port of this unit may have been filtered by the firewall function of the virus check software. | <ul style="list-style-type: none"> Change the HTTP port number of this unit to a port number that is not filtered. | – |
| The lamps are not lit. | <ul style="list-style-type: none"> Is the lamp setting set to [Off] in the [Basic] in the setting menu? | <ul style="list-style-type: none"> Set the lamp setting to [On]. | User Manual |
| The H.265 (or H.264) image does not appear smoothly. | <ul style="list-style-type: none"> Refer to the right. | – | → 6.1 Required PC Environment |
| Clicking the Back button on the Web browser does not display the correct screen. | <ul style="list-style-type: none"> Press the [F5] key on the PC keyboard to update the screen. | – | – |
| Image does not match display frame | <ul style="list-style-type: none"> If the DPI setting of the image is 120 DPI or higher, the image may not be displayed correctly. | <ul style="list-style-type: none"> Right-click the PC screen and select [Display Settings].> Set the [Resize text, app, and other items] slide bar to [100% (recommended)]. Use [Orientation] with [Horizontal] set. | – |
| "Access is concentrated. Run after a while" is displayed on the Live image pages. | <ul style="list-style-type: none"> Change the [Initial display stream] setting to the lower [Max bit rate (per client) *] streams. If the problem persists, change the [Bit Rate* per Client] setting on the stream to a lower value. | – | User Manual |

7.18 Precautions pertaining to usage

- **Do not subject dome cover to strong impact.**

Doing so may cause damage or immersion.

- **Do not directly touch the lens and domecover with your bare hands.**

A dirty dome cover or lens causes deterioration of picture quality.

- **Effects on images and image quality**

Under the following conditions, image quality may deteriorate or images may become difficult to see.

- When there are raindrops on the dome cover due to wind during rainfall.
- When there is snow on the dome cover due to wind during snowfall. (varies depending on the amount and quality of snowfall).
- When the dome cover is dirty due to dust in the air or vehicle exhaust.

- **Make sure to remove this product if it will no longer be used.**

- **This product has no power switch.**

When turning off the power, disconnect the power supply from the PoE+ device.

- **About the battery**

A battery is installed inside the camera. Do not leave the battery exposed in environments of excessive heat as a result of sunlight or fire.

- **AVC Patent Portfolio License**

THIS PRODUCT IS LICENSED UNDER THE AVCPATENT PORTFOLIO LICENSE FOR THE PERSONAL USE OF A CONSUMER OR OTHER USES IN WHICH IT DOES NOT RECEIVE REMUNERATION TO (i) ENCODE VIDEO IN COMPLIANCE WITH THE AVC STANDARD (“AVC VIDEO”) AND/OR (ii) DECODE AVC VIDEO THAT WAS ENCODED BY A CONSUMER ENGAGED IN A PERSONAL ACTIVITY AND/OR WAS OBTAINED FROM A VIDEO PROVIDER LICENSED TO PROVIDE AVC VIDEO. NO LICENSE IS GRANTED OR SHALL BE IMPLIED FOR ANY OTHER USE. ADDITIONAL INFORMATION MAY BE OBTAINED FROM MPEG LA, L.L.C.
SEE [HTTP://WWW.MPEGLA.COM](http://www.mpegla.com)

- **Open Source Software**

- This product contains open source software licensed under GPL (GNU General Public License), LGPL (GNU Lesser General Public License), etc.
- Customers can duplicate, distribute and modify the source code of the software under license of GPL and/or LGPL.
- For details concerning licensing and source code of open source software, click “Click here

for OSSinformation” on “Support” page of the setup menu of this product and read the displayed content.

- Please note that we shall not respond to any inquiries regarding the contents of the source code.

- **Copyright**

Except for open source software licensed under GPL/LGPL and so on, distributing, copying, disassembling, reverse compiling and reverse engineering of the software provided with this product are all expressly prohibited. In addition, exporting any software provided with this product violating export laws is prohibited.

- **For trademarks and registered trademarks**

- Microsoft, Windows, Windows Media, Microsoft Edge, and ActiveX are either registered trademarks or trademarks of Microsoft Corporation in the United States and/or other countries.
- Intel and Intel Core are trademarks of Intel Corporation or its subsidiaries in the U.S. and/or other countries.
- Adobe, Acrobat, and Reader are either registered trademarks or trademarks of Adobe in the United States and/or other countries.
- microSDXC Logo is a trademark of SD-3C, LLC.
- iPad and iPhone are trademarks of Apple Inc., registered in the U.S. and other countries.
- Android and Google Chrome are trademark of Google LLC.
- Firefox is a trademark of the Mozilla Foundation in the US and other countries.
- The word “QR Code” is a registered trademark of DENSO WAVE INCORPORATED in Japan and other countries.
- All other trademarks identified herein are the property of their respective owners.

- **About HEVC High Efficiency Video Coding patents**

Covered by one or more claims of the HEVC patents listed at patentlist.accessadvance.com.

7.19 Disclaimer

IN NO EVENT SHALL i-PRO Co., Ltd. BE LIABLE TO ANY PARTY OR ANY PERSON, EXCEPT FOR REPLACEMENT OR REASONABLE MAINTENANCE OF THE PRODUCT, FOR THE CASES, INCLUDING BUT NOT LIMITED TO BELOW: The purpose of this product is to obtain images for monitoring specific areas. This product alone is not intended to prevent crimes.

- (1) ANY LOSS OR DAMAGE, INCLUDING WITHOUT LIMITATION, DIRECT OR

INDIRECT, SPECIAL, CONSEQUENTIAL OR EXEMPLARY, ARISING OUT OF OR RELATING TO THE PRODUCT

- (2) ANY INCONVENIENCE, LOSS, OR DAMAGE CAUSED BY INAPPROPRIATE USE OR NEGLIGENT OPERATION OF THE USER;
- (3) ALL MALFUNCTIONS OR TROUBLES FROM UNAUTHORIZED DISASSEMBLE, REPAIR OR MODIFICATION OF THE PRODUCT BY THE USER, REGARDLESS OF THE CAUSE OF THE MALFUNCTION OR TROUBLE;
- (4) INCONVENIENCE OR ANY LOSS ARISING WHEN IMAGES ARE NOT DISPLAYED, DUE TO ANY REASON OR CAUSE INCLUDING ANY FAILURE OR PROBLEM OF THE PRODUCT;
- (5) ANY PROBLEM, CONSEQUENTIAL INCONVENIENCE, OR LOSS OR DAMAGE, ARISING OUT OF THE SYSTEM COMBINED BY THE DEVICES OF THIRD PARTY;
- (6) ANY CLAIM OR ACTION FOR DAMAGES BROUGHT BY ANY PERSON OR ORGANIZATION AS A PHOTOGRAPHED SUBJECT DUE TO VIOLATION OF PRIVACY CONCERNING A SURVEILLANCE CAMERA'S PICTURE OR SAVED DATA, FOR SOME REASON (INCLUDING USE WHEN USER AUTHENTICATION ON THE AUTHENTICATION SETTING SCREEN IS SET TO OFF), BECOMING PUBLIC OR BEING USED FOR ANY PURPOSE;
- (7) LOSS OF REGISTERED DATA CAUSED BY ANY FAILURE (INCLUDING INITIALIZATION OF THE PRODUCT DUE TO FORGOTTEN AUTHENTICATION INFORMATION SUCH AS A USERNAME AND PASSWORD).

Limitation of liability

THIS PUBLICATION IS PROVIDED "AS IS" WITHOUT WARRANTY OF ANY KIND, EITHER EXPRESS OR IMPLIED, INCLUDING BUT NOT LIMITED TO, THE IMPLIED WARRANTIES OF MERCHANTABILITY, FITNESS FOR ANY PARTICULAR PURPOSE, OR NON-INFRINGEMENT OF THE THIRD PARTY'S RIGHT.

THIS PUBLICATION COULD INCLUDE TECHNICAL INACCURACIES OR TYPOGRAPHICAL ERRORS. CHANGES ARE ADDED TO THE INFORMATION HEREIN, AT ANY TIME, FOR THE IMPROVEMENTS OF THIS PUBLICATION AND/OR THE CORRESPONDING PRODUCT (S).

7.20 Network security

As you will use this unit connected to a network, your attention is called to the following security risks.

- ① Leakage or theft of information through this unit
- ② Use of this unit for illegal operations by persons with malicious intent
- ③ Interference with or stoppage of this unit by persons with malicious intent

It is your responsibility to take precautions such as those described below to protect yourself against the above network security risks.

- Use this unit in a network secured by a firewall, etc.
- If this unit is connected to a network that includes PCs, make sure that the system is not infected by computer viruses or other malicious entities (using a regularly updated anti-virus program, anti-spyware program, etc.).
- To prevent unauthorized access, use user-authentication, set user names and passwords, and limit which users can log in.
- Apply measures such as user authentication to protect your network against leakage or theft of information, including image data, authentication information (user names and passwords), alarm mail information and DDNS server information.
- After the unit is accessed by the administrator, make sure to close the browser.
- Change the administrator password periodically. Additionally, save user authentication information (user names and passwords) in such a way that it is kept out of the hands of third parties.
- Do not install the camera in locations where the camera or the cables can be destroyed or damaged by persons with malicious intent.