

# WV-U61301-Z2

2MP (1080p) 21x Indoor PTZ Network Camera

## U series PTZ camera

U-Series launch gives customers PTZ's that meet top security certifications (FIPS 140-2 level 3) while also providing a unique blend of imaging performance, reliability and affordability.



- 2MP (1080p) 1920x1080
- 21x optical zoom
- Intelligent Auto
- Super Dynamic 144dB
- Color night vision (0.001 to 0.015 lx)
- Durable Pan/Tilt gear mechanism
- Built-in FIPS 140-2 Level 3 Certified Secure Element  
(EdgeLock® SE050F NXP® Semiconductors)
- NDAA Compliant



# SPECIFICATIONS

Camera	
Image Sensor	Approx. 1/2.8 type CMOS image sensor
Minimum Illumination	Color : 0.015 lx (50IRE, F1.6, 1/30s) Color : 0.001 lx (50IRE, F1.6, 16/30s) BW : 0.006 lx (50IRE, F1.6, 1/30s) BW : 0.0004 lx (50IRE, F1.6, 16/30s)
White Balance	ATW1 / ATW2 / AWC
Shutter Speed	[60 fps Mode] 1/60 Fix to 1/10000 Fix, [30 fps/15 fps mode] 1/30 Fix to 1/10000 Fix [50 fps Mode] 1/50 Fix to 1/10000 Fix, [25 fps/12.5 fps mode] 1/25 Fix to 1/10000 Fix
Intelligent Auto	On / Off
Super Dynamic	On / Off, the level can be set in the range of 0 to 31.
Dynamic Range	Max.144 dB (Super Dynamic : On, Level 31)
Back light compensation / High light compensation	BLC (Back light compensation) / HLC (High light compensation) / Off The level can be set in the range of 0 to 31 (only when Super dynamic / Intelligent Auto : Off)
Fog compensation	On / Off, The level can be set in the range of 0 to 8 (only when Intelligent auto / auto contrast adjust : Off)
Maximum gain (AGC)	The level can be set in the range of 0 to 11.
Color/BW (ICR)	Off / On / Auto1 / Auto2 / Auto3 (SCC)
Digital Noise Reduction	The level can be set in the range of 0 to 255.
Video Motion Detection (VMD)	On / Off, 4 areas available
Scene Change Detection (SCD)	On / Off, 1 areas available
Audio Detection	On / Off
AI Sound Classification	—
AI Analytics	—
Privacy Zone	On / Off, Up to 32 zones available
VIQS	On / Off, Up to 8 zones available
Image Stabilizer	On / Off (Built-in gyro sensor)
Camera Title (OSD)	On / Off, Up to 40 characters (alphanumeric characters, marks)
Focus Adjustment	Auto focus
Lens	
Optical zoom	21x (Motorized zoom / Motorized Focus)
Extra zoom	Max. 31x (21 to 31x : When resolution is 1280 x 720)
Focal Length	4.0 - 84.6 mm {5/32 inches - 3-21/64 inches}
Angular Field of View	[16 : 9 mode] Horizontal : 3.7° (TELE) - 77° (WIDE), Vertical : 2.2° (TELE) - 44° (WIDE) [4 : 3 mode] Horizontal : 2.8° (TELE) - 58° (WIDE), Vertical : 2.2° (TELE) - 44° (WIDE)
Maximum Aperture Ratio	1 : 1.6 (WIDE) - 1 : 4.5 (TELE)
Focus Range	1.5 m {50-1/16 inches} - ∞
DORI	
Detect (25ppm / 8ppf)	Wide: 51.9m / 170.3 ft, Tele: 1293.8 m / 4244.9 ft

Observe (62.5ppm / 19ppf)	Wide: 20.8 m / 68.1 ft, Tele: 517.5 m / 1697.9 ft
Recognize (125ppm / 38ppf)	Wide: 10.4 m / 34.1 ft, Tele: 258.8 m / 849.0 ft
Identify (250ppm / 76ppf)	Wide: 5.2m / 17.0 ft, Tele: 129.4 m / 424.5 ft
<b>System on Chip (SoC)</b>	
System on Chip (SoC)	Ambarella CV25M
<b>Adjusting Angle</b>	
Adjusting Angle	Horizontal : 0 to +350°, Vertical : -30 to +90°, Yaw : 0°
<b>Pan/tilt</b>	
Panning Range	0° – 350°
Panning Speed	Manual: Approx. 0.065°/s – 150°/s , Preset: Up to approx. 500°/s
Tilting Range	Operational -30° – +90°
Tilting Speed	Manual: Approx. 0.065°/s –150°/s , Preset: Up to approx. 350°/s
Preset Positions	256 positions
Auto Mode	Auto pan/ Preset sequence/ Patrol
Self Return	10 s/ 20 s/ 30 s/ 1 min/ 2 min/ 3 min/ 5 min/ 10 min/ 20 min/ 30 min/ 60 min
<b>Browser GUI</b>	
Camera Control	Brightness, AUX On / Off
Audio	Mic (Line) Input : On / Off Volume adjustment : Low / Middle / High Audio Output : On / Off Volume adjustment : Low / Middle / High
GUI / Setup Menu Language	English, Italian, French, German, Spanish, Portuguese, Russian, Chinese, Japanese
Browser	Microsoft Edge, Firefox, Google Chrome
<b>Network</b>	
Network IF	10 Base-T / 100 Base-TX, RJ45 connector
Resolution H.265/ H.264 JPEG (MJPEG)	[16 : 9 mode (60 fps mode)] , [16 : 9 mode (30 fps mode)], [16 : 9 mode (50 fps mode)], [16 : 9 mode (25 fps mode)] : 1920x1080, 1280x720, 640x360, 320x180 [4 : 3 mode (30 fps mode)], [4 : 3 mode (25 fps mode)] : 1280x960, VGA, QVGA [4 : 3 mode (15 fps mode)], [4 : 3 mode (12.5 fps mode)] : 2048x1536 , 1280x960, VGA, QVGA
H.265/H.264	[Transmission Mode] Constant bit rate / VBR / Frame rate / Best effort [Transmission Type] Unicast port (AUTO) / Unicast port (MANUAL) / Multicast
JPEG	[Image Quality] 10 steps
Smart Coding	GOP (Group of pictures) control: Off/ Low (Variable GOP 1s-8s)/ Mid (Variable GOP 4s-16s)/ Advanced(Fixed GOP 60s w/1s key-frame) / Frame rate control (Variable GOP 4s-16s with frame rate control) *Advanced and Frame rate control are only available with H.265. Smart Coding: Auto VIQS: On/Off
Audio Compression	G.726 (ADPCM) : 16 kbps / 32 kbps , G.711 : 64 kbps , AAC-LC : 64 kbps / 96 kbps / 128 kbps
Audio Transmission Mode	Off / Mic (Line) input / Audio output / Interactive (Half duplex) / Interactive (Full duplex)
Supported Protocol	IPv6 : TCP/IP, UDP/IP, HTTP, HTTPS, SSL/TLS, SMTP, DNS, NTP, SNMPv1/v2/v3, DHCPv6, RTP, MLD, ICMP, ARP, IEEE 802.1X, DiffServ, SFTP, MQTT, LLDP IPv4 : TCP/IP, UDP/IP, HTTP, HTTPS, SSL/TLS, RTSP, RTP, RTP/RTCP, SMTP, DHCP, DNS, DDNS, NTP, SNMPv1/v2/v3, UPnP, IGMP, ICMP, ARP, IEEE 802.1X, DiffServ, SRTP, SFTP, MQTT, LLDP, NTCIP
No. of Simultaneous Users	Up to 14 users (Depends on network conditions)
Secure	FIPS 140-2 level 3 Certified Secure Element (NXP® EdgeLock® SE050F), Device Certificate GlobalSign® pre-installed, User authentication, Host authentication, HTTPS, 802.1X Support, Data encryption
SDXC/SDHC/SD Memory Card (Option)	H.265 / H.264 recording : Manual REC / Alarm REC (Pre/Post) / Schedule REC / Backup upon network failure JPEG recording : Manual REC / Alarm REC (Pre/Post) / Backup upon network failure Compatible SDXC/SDHC/SD Memory Card : microSDXC memory card : 64 GB, 128 GB, 256 GB, 512 GB microSDHC memory card : 4 GB, 8 GB, 16 GB, 32 GB , microSD memory card : 2 GB

Mobile Terminal Compatibility	iPad, iPhone (iOS 8.0 or later), Android™ terminals
ONVIF® Profile	G / S / T
<b>Alarm</b>	
Alarm Source	3 terminals input, VMD alarm, Command alarm, Audio detection alarm
Alarm Actions	SDXC/SDHC/SD memory recording, E-mail notification, HTTP alarm notification Indication on browser, TCP alarm notification output
<b>Input/Output</b>	
Audio Input	ø3.5 mm stereo mini jack For microphone input : Recommended applicable microphone : Plug-in power type (Sensitivity of microphone : -51 dB to -38 dB (0 dB=1 V/Pa, 1 kHz)) Input impedance : Approx. 2 kΩ (unbalanced) / Supply voltage : 2.5 V ±0.5 V For line input : Input level : Approx. -10 dBV
Audio Output	ø3.5 mm stereo mini jack (monaural output) Output impedance : Approx. 600 Ω (unbalanced) , Output level : -20 dBV
External I/O Terminals	ALARM IN 1 (Alarm input 1/ Black & white input/ Auto time adjustment input) (x1) ALARM IN 2 (Alarm input 2/ ALARM OUT) (x1), ALARM IN 3 (Alarm input 3/ AUX OUT) (x1)
Safety	UL (UL62368-1), c-UL (CSA C22.2 No.62368-1), CE, IEC62368-1
EMC	FCC (Part15 ClassA), ICES-003 Issue 7 ClassA, EN55032 ClassA, EN55035
Power Source and Power Consumption	DC12 V, PoE (IEEE802.3af) , DC12 V: 970 mA / Approx. 11.6 W PoE DC 48 V: 270 mA / Approx.12.95 W (Class 0device)
Ambient Operating Temperature	-10 °C to +50 °C (+14 °F to +122 °F) (Power On range : 0 °C to +50 °C {+32 °F to +122 °F})
Ambient Operating Humidity	10 to 90 % (no condensation)
Anti-Condensation System	—
Dimensions	ø117 mm x 155 mm (H) {ø4-19/32 inches x 6-3/32 inches (H)}
Mass (Approx.)	Approx. 1.2 kg {2.65 lbs.}
Finish	Main body : Resin, i-PRO white

## NOTES

### Important

- Safety Precautions : Carefully read the Basic Information, Installation Guide and Operating Instructions before using this product.
- i-PRO Co., Ltd. cannot be held responsible for the performance of the network and/or other manufacturers' products used on the network.
- Masses and dimensions are approximate.
- Specifications are subject to change without notice.

### Trademarks and registered trademarks

- iPad and iPhone are trademarks of Apple Inc., registered in the U.S. and other countries. - Android is a trademark of Google LLC.
- ONVIF is a trademark of ONVIF, Inc.
- All other trademarks identified herein are the property of their respective owners

©i-PRO Co., Ltd All rights reserved / November 2022

## OPTIONAL ACCESSORIES

Select a compatible accessory

[Accessory Selector \(i-pro.com\)](http://i-pro.com).



WV-Q105A  
Mount Bracket



WV-QCL100-W  
Mount Bracket



WV-QCL101-W  
Mount Bracket



WV-QCN500-W  
Mount Bracket



WV-QED100C-W  
Ceiling Mount Bracket



WV-QED100G-W  
Ceiling Mount Bracket



WV-QJB500-W  
Mount Bracket



WV-QPL500-W  
Mount Bracket



WV-QWD100C-W  
Wall Mount Bracket



WV-QWD100G-W  
Wall Mount Bracket



WV-QWL500-W  
Mount Bracket



WV-QAT100  
Inner Cover



WV-QCD100C-W  
Dome Cover



WV-QCD100G-W  
Dome Cover



WV-PM500  
Compact microphone  
unit for surveillance  
cameras

# APPEARANCE

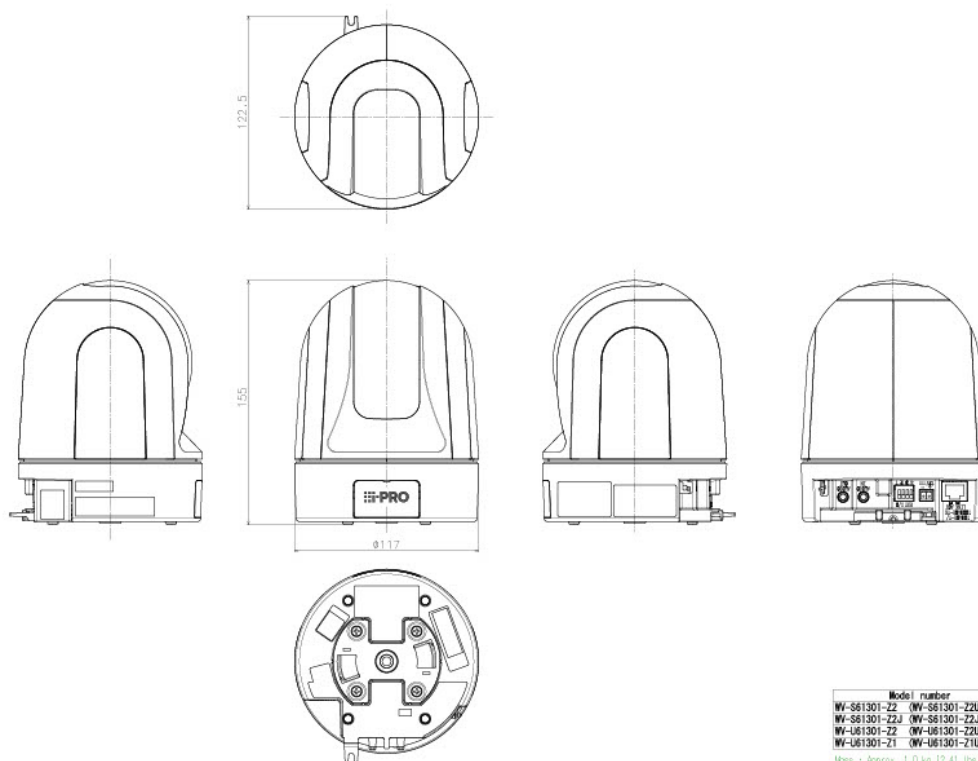

Model number	Lens type
WV-S61301-22 (WV-S61301-22US)	
WV-S61301-22J (WV-S61301-22JUS)	x21
WV-U61301-22 (WV-U61301-22US)	
WV-U61301-21 (WV-U61301-21US)	x10

Mass : Approx. 1.0 kg [2.41 lbs]

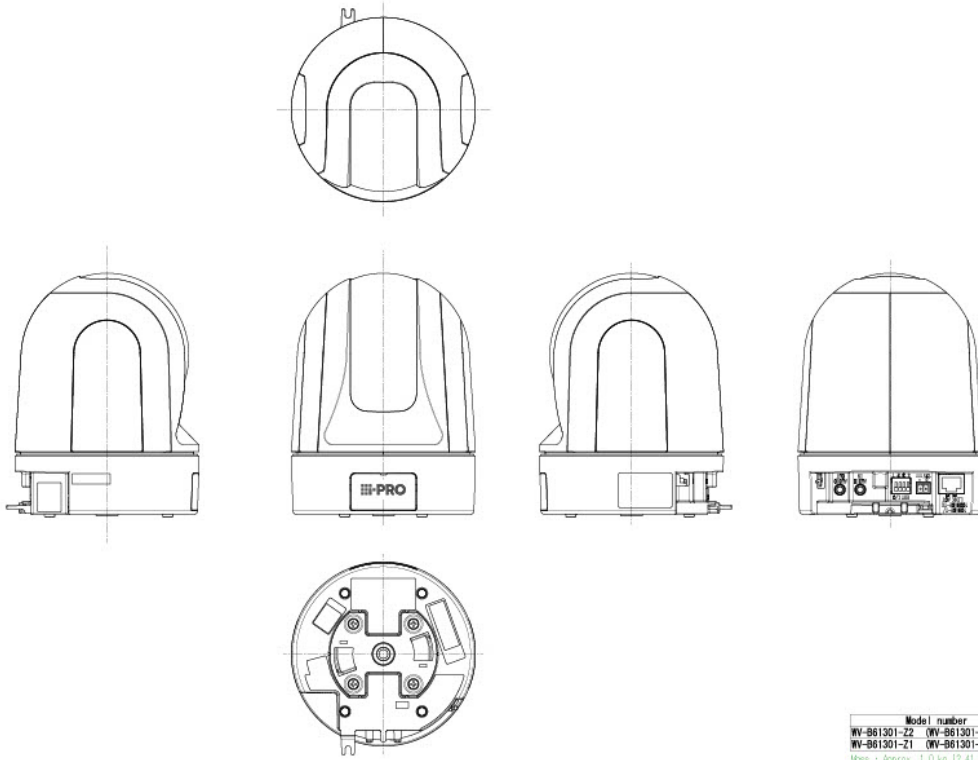

Model number	Lens type
WV-B61301-Z2 (WV-B61301-Z2US)	x21
WV-B61301-Z1 (WV-B61301-Z1US)	x10

Mass : Approx. 1.0 kg [2.41 lbs]

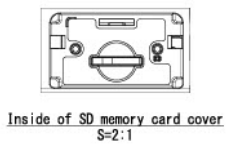

Inside of SD memory card cover  
S=2:1

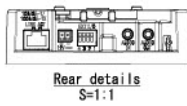

Rear details  
S=1:1

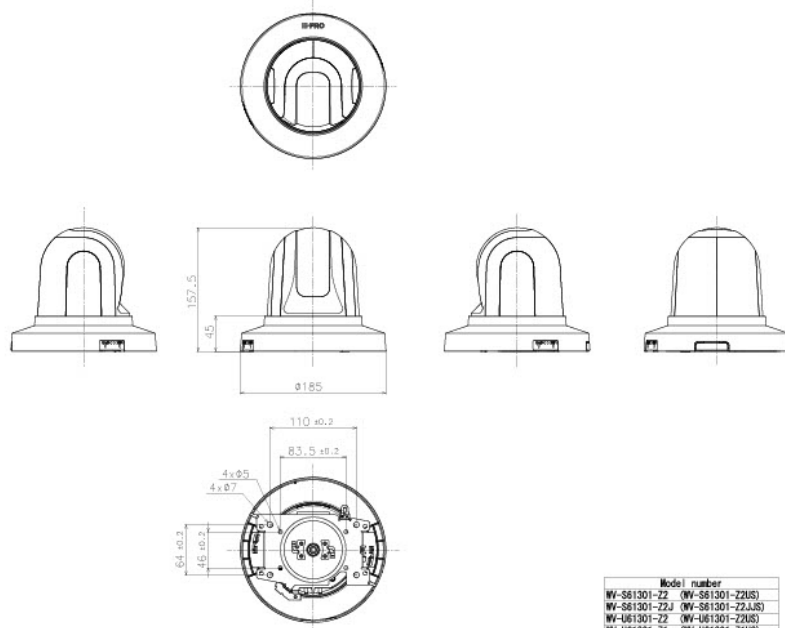

With Decorative cover & Camera mount bracket

Model number
WV-S61301-Z2 (WV-S61301-Z2US)
WV-S61301-Z3 (WV-S61301-Z3US)
WV-U61301-Z2 (WV-U61301-Z2US)
WV-U61301-Z1 (WV-U61301-Z1US)
WV-B61301-Z2 (WV-B61301-Z2US)
WV-B61301-Z1 (WV-B61301-Z1US)

Mass : Approx. 1.2 kg [2.65 lbs]  
(Including Decorative cover and Camera mount bracket)

**金具との組み合わせ例**  
**Example of combination with bracket**

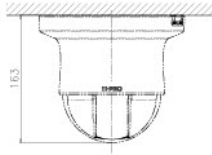

**Attach to WV-QCD100C-W**

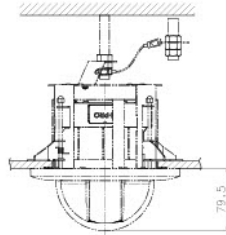

**Attach to WV-QED100C-W**

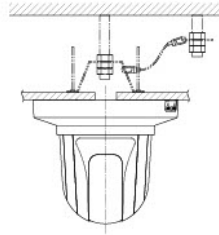

**Attach to WV-QAT105A**

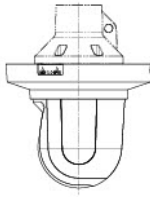

**Attach to WV-QQL100-W**

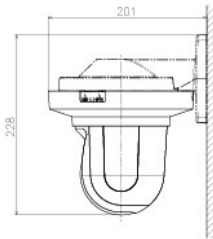

**Attach to WV-QWL500-W**

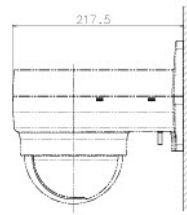

**Attach to WV-QWD100C-W**

Model number	
WV-S61301-ZZ	(WV-S61301-ZZUS)
WV-S61301-ZZJ	(WV-S61301-ZZJUS)
WV-U61301-ZZ	(WV-U61301-ZZUS)
WV-U61301-Z1	(WV-U61301-Z1US)
WV-B61301-ZZ	(WV-B61301-ZZUS)
WV-B61301-Z1	(WV-B61301-Z1US)