

WISENET

NETWORK VIDEO RECORDER

Quick Guide

PRN-6400DB4/PRN-6400B4/PRN-3200B4

PRN-6405DB4/PRN-6405B4/PRN-3205B4

CE









Features

The product records video and audio from network cameras to a hard disk, and enables playback from the hard disk. It also provides remote monitoring environment for video and audio over the network using a remote computer.

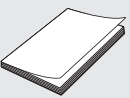
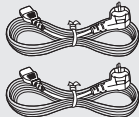
- Provides AI function (Wisenet Non-AI P/X series camera, X Lite excluded)
- Provides the function of searching for AI faces (when using Wisenet AI camera)
- Provides the function of recognizing and searching for AI vehicle license plates (PRN-6400DB4/PRN-6400B4/PRN-3200B4)
- Can be linked to AI camera
- Supports AI search (Person, Vehicle, License Plate)
- Supports BestShot view
- Provides new UI 2.0
- Supports instant viewer
- Bookmark function
- Thumbnail function
- View camera event list in real time
- Convenient event rule setup
- Various sequence (layout, page) functions
- Extended search period
- Convenient log search
- Supports thermal imaging camera/PTZ linked camera
- Supports a range of 4K camera resolutions
- Outputs a 4K high definition image using HDMI
- Supports dual monitor output (expand, duplicate)
- Record and play video
- Record and play audio
- Supports ONVIF Profile S standard and RTP / RTSP protocols
- Display the HDD operation status by HDD SMART
- HDD overwrite enabled
- Function to export using USB memory and external hard disk
- Simultaneous play of 32, 64 channels
- View multi-channel time line when playing videos
- Various Search Modes (Time, Event, Smart, Text, Export, ARB)
- ARB support (configuration feature for saving period by channel)
- Various recording modes (Normal, Event, Scheduled Recording)
- Alarm Input / Output
- Remote monitoring function by Windows Network Viewer
- Live monitoring of the network camera
- Installation Wizard Function (Recorder, Web Viewer)
- Supports the smartphone remote monitoring feature by P2P support
- Provides smartphone event alarm (sending real-time event messages)

Hanwha Techwin Co., Ltd. is a surveillance camera manufacturer that provides video information equipment with various functions. Users must comply with local laws when using our devices. Users are solely responsible for any illegal use of our products.

Package Contents

		
Recorder	Mouse	Quick Guide
		
Power Cord (2 ea) (PRN-6400DB4/PRN-6405DB4)	Power Cord (1 ea) (PRN-6400B4/PRN-3200B4/ PRN-6405B4/PRN-3205B4)	Terminal Block
		
Front Cover Lock Key	HDD Fixing Screw	Anti-slip Rubber Pad
		
Hard Disk Number Sticker		

CAUTION

- RISK OF EXPLOSION IF BATTERY IS REPLACED BY AN INCORRECT TYPE. DISPOSE OF USED BATTERIES ACCORDING TO THE INSTRUCTIONS.
- Do not ingest battery, Chemical Burn Hazard.
- This product contains a coin / button cell battery. If the coin / button cell battery is swallowed, it can cause severe internal burns in just 2 hours and can lead to death.
- Keep new and used batteries away from children. If the battery compartment does not close securely, stop using the product and keep it away from children. If you think batteries might have been swallowed or placed inside any part or the body, seek immediate medical attention.

ATTENTION

- IL Y A RISQUE D'EXPLOSION SI LA BATTERIE EST REMPLACÉE PAR UNE BATTERIE DE TYPE INCORRECT. METTRE AU REBUT LES BATTERIES USAGÉES CONFORMÉMENT AUX INSTRUCTIONS.
- Ne pas ingérer la pile, risque de brûlure chimique.
- Ce produit contient une pile de type bouton/pièce de monnaie. Si la pile de type bouton/pièce de monnaie est avalée, elle peut causer de graves brûlures internes en seulement 2 heures et peut entraîner la mort.
- Gardez les piles neuves et usagées hors de portée des enfants. Si le compartiment de la pile ne se ferme pas correctement, cessez d'utiliser le produit et gardez-le d'atteinte des enfants. Si vous suspectez que des piles ont été avalées ou insérées dans une partie du corps, consultez un médecin sans tarder.

Installing the HDD

- 1 Use the front cover lock key to unlock the cover. Grab the front cover with both hands and pull it to the left to remove it.

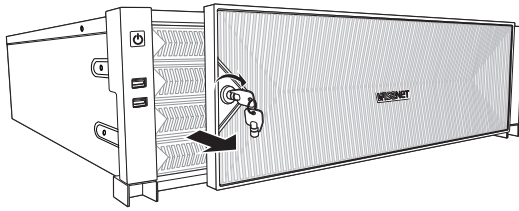

- 2 Press the orange button on the hard disk bracket to the left and pull forward to separate the main body and the hard disk bracket.

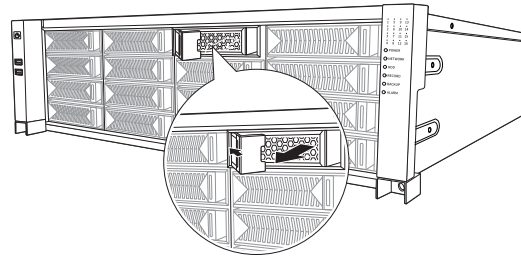

- 3 Mount a HDD in the HDD bracket and screw it in using the screws provided.

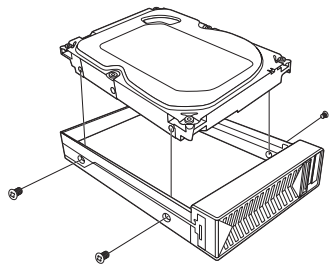

- 4 Once the HDD is mounted in the bracket, push the bracket into the main body and close the front cover.
 - Fit the front cover into the right notch of the main body, then press and close until you hear a 'click'.
 - Use the front cover lock key to lock the front cover so that it does not get separated.

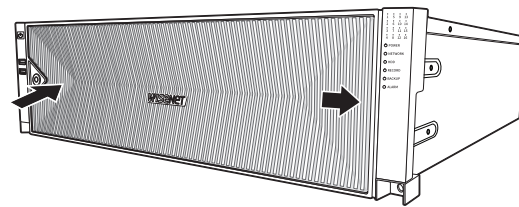

- ! If you are adding a new or previously used HDD to this product in addition to the HDD(s) originally installed, format the new HDD manually in the set before use.
- For replacement or installation of an additional HDD you must contact your dealer or our customer center.

Installing the Rack

Rack Installation Requirements and Reference Dimensions

Classification	Requirements
Rack type	19-inch rack of EIA-310-D standard
POST count	4
POST distance	Depth 800 mm

Dimensions of mounting flange

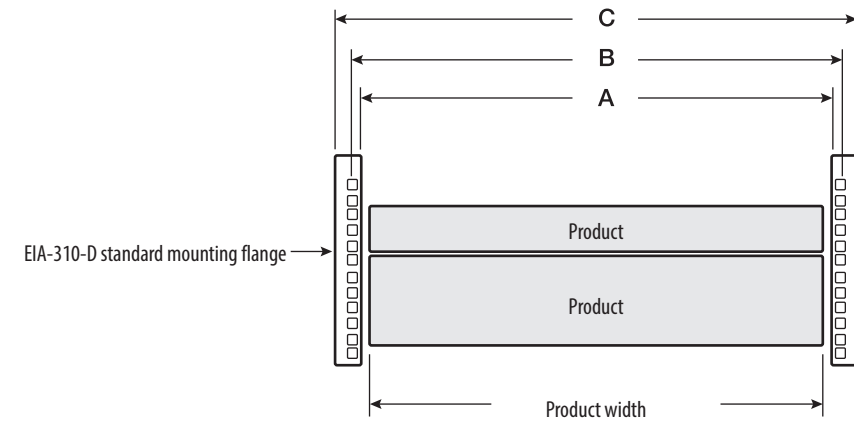

Notable dimensions

Index	Dimension
A	450 mm (17.717 inches) min.
B	465 mm (18.307 inches) nominal
C	483.4 mm (19.031 inches) min.

Flange mounting holes (square holes are recommended for PRN-6400/PRN-6405 series)

While EIA-310-D standard allows the mounting flange holes to be round, square, or tapped (threaded), the PRN-6400/PRN-6405 series is only designed to work with round or square holes, but not tapped holes.

Square mounting holes

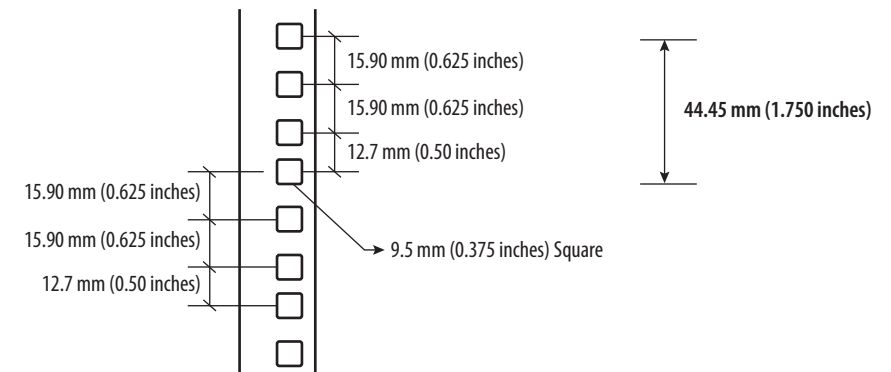

Recommended rack dimensions

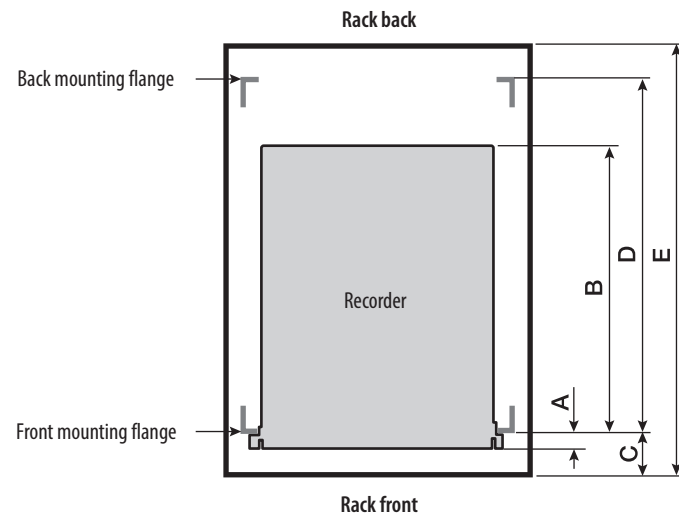

Index	Dimension	Description
A	28 mm	Recorder front dimension
B	560 mm	Recorder product dimension
C	51 mm	Offset distance between mounting flange and rack front
D	617~730 mm	Offset distance between mounting flanges
E	800 mm	Rack depth

Precautions when Selecting Shelves

To prevent any problem while installing the recorder, make sure to select a structure where the bottom of the product is mounted.

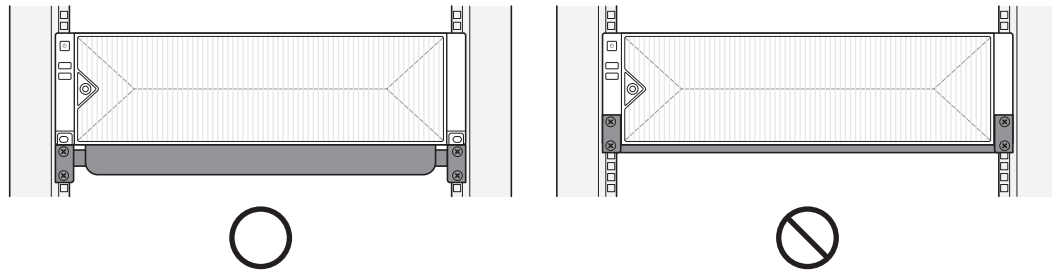

For installation stability, fixed shelf dedicated to 19-inch rack that supports the load of at least 30 kg is recommended.

- A shelf needs to be secured with at least 4 screws.

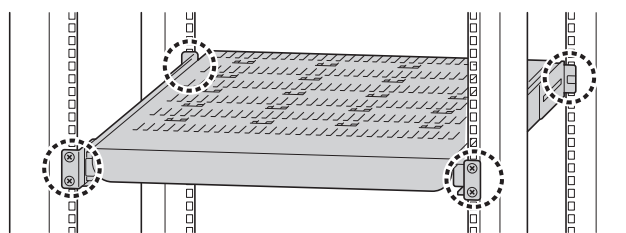

Precautions when Using Sliding Shelves

When removing a shelf, fix the rack to the ground so that it does not get toppled.

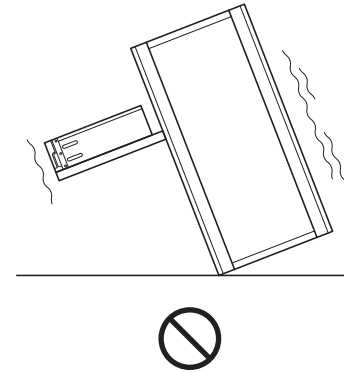

Avoid leaning on the installed product or place an object on it while its shelf is pulled out.

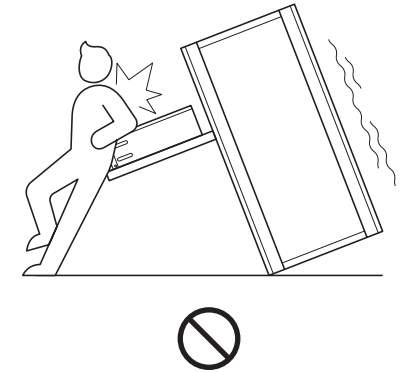

When sliding in/out the shelf, be careful not to drop the product.

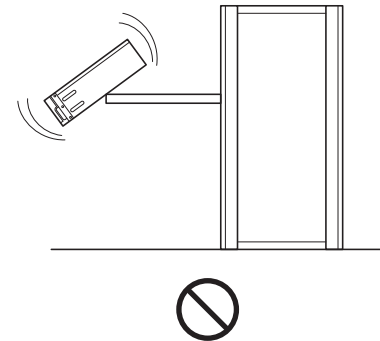

Use a shelf that supports the load of at least 30 kg while it is pulled out, and ensure that there is no deformation on the rail part while in use.

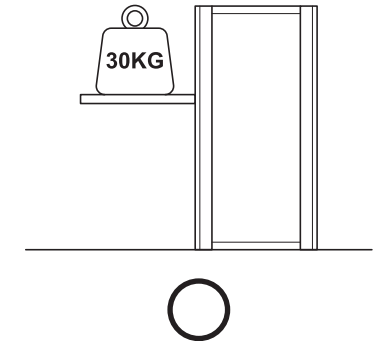

How to Install Rack

1 Mount the fixed or sliding shelf onto the 19-inch rack.

- See the manual provided by the manufacturer for installing the fixed shelf.

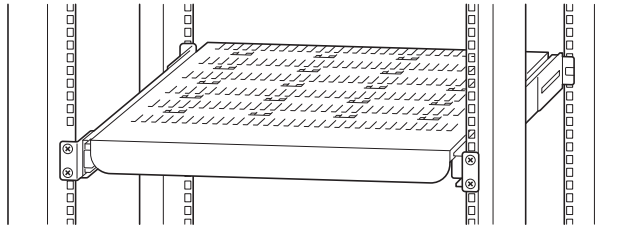

2 Place the recorder on the shelf and push it until the left/right fixing holes of the recorder align with the mounting flange holes of the 19-inch rack.

- Cage nuts must be assembled in the mounting flange holes of the 19-inch rack.

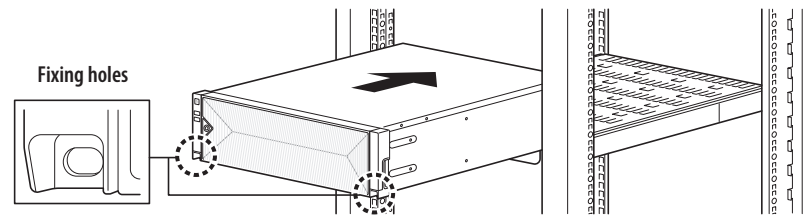

3 Insert the screws in the left/right fixing holes of the recorder to secure the recorder.

- Fixing nuts and cage nuts for the recorder are not shipped with the product. They are separately sold at the place where you purchased the shelf or rack.
(M6 nuts and cage nuts of head size equal to 12 mm or less are recommended.)

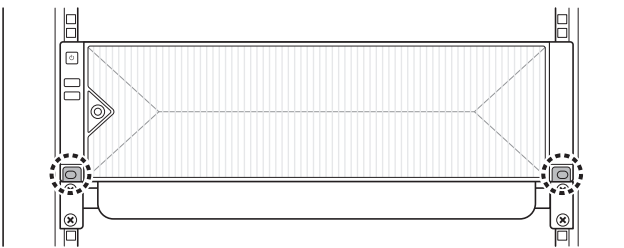

Install Wizard Setup

As shown below, proceed through each step of the <Install Wizard>. Install Wizard can only be accessed at factory reset. If you do not want to proceed, click <Exit>.



- You can set the install wizard on the recorder and web viewer. Refer to the User Manual for instructions on how to set up the install wizard on the web viewer.
- When you complete installation using the install wizard on your recorder, the install wizard will not appear on your web viewer.

1 Select the language

Select your preferred language.

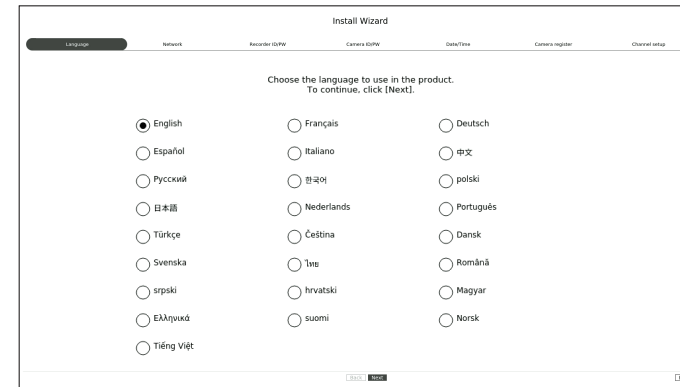

2 Network Settings

- DHCP server : If the DHCP server is set to enable, an IP is automatically assigned to the camera.
 - Network 1 (Camera) : Port for camera connections; it receives video from a camera.
 - Network 2 (Viewer) : This is a port for transmitting an image to the webviewer.
 - Network 3 (iSCSI) : This is a port for connecting an external iSCSI.
 - Network 1 / Network 2 / Network 3 Setup
 - IP Type : Choose the network connection method.
 - IP Address, Subnet Mask, Gateway, DNS
 - Enable online upgrade
 - You can receive a new firmware notification when your device is connected to a network.
- ※ For more details on network settings, refer to the User manual.
- ▶ To use a simple intranet, click <Next>.

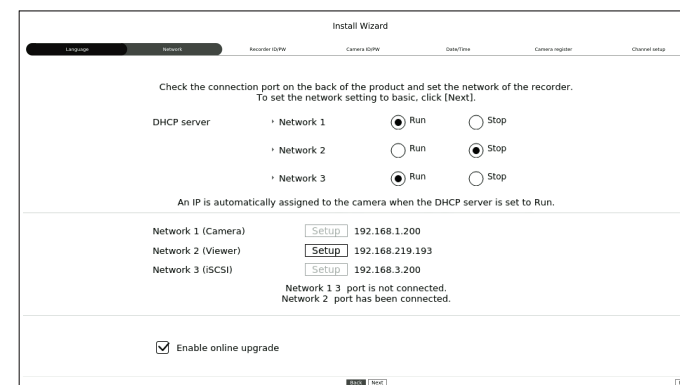

3 Recorder ID/PW Setup

Sets the administrator's password.

Install Wizard

Language Network Recorder ID/PW Camera ID/PW Date/Time Camera register Channel setup

Set a recorder password.

ID admin (Administrator)

Initial password [masked] ⓘ

Confirm Password [masked]

View password

Back Next

※ Click < ⓘ > to view the basic guide for setting a password. Refer to the password setup rules.

4 Camera ID/PW Setup

4-1. Set a camera password in factory reset. The initial password for the camera must be entered.

4-2. If ID/PW is already set in the camera, register the ID/PW and click <Next>.

Install Wizard

Language Network Recorder ID/PW Camera ID/PW Date/Time Camera register Channel setup

Set the password of the factory default Wisenet camera

Use the recorder administrator ID and password as the camera account

Initial password [masked] Confirm Password [masked] ⓘ

View password

Register the camera ID for which the password had been set and the password (up to 3)

Enter the camera ID and password

ID [] Password [] [-] [+]

View password

Back Next

※ Click < ⓘ > to view the basic guide for setting a password. Refer to the password setup rules.

※ When the password is in factory reset, it can be changed and managed in a batch.

※ Up to 3 sets of camera ID with password and password can be registered.

※ You cannot change the password for cameras registered with ONVIF and RTSP.

5 Date/Time Setup

Set the date, time, time zone, and DST and then click <Next>.

Install Wizard

Language Network Recorder ID/PW Camera ID/PW Date/Time Camera register Channel setup

Set the system time of the product.

Date 2020-06-29 YYYY-MM-DD

Time 04:39:24 24 Hours

Time zone GMT

Daylight saving time Mar Last (Sun) 1H Oct Last (Sun) 1H

Back Next

6 Camera Register

Registers the searched network cameras.

6-1 Select a camera to register from the searched camera list and click <Register>.

6-2 Select a camera to register from the list and click <Change IP>.

6-3 After completing camera register, click <Next>.

Install Wizard

Language Network Recorder ID/PW Camera ID/PW Date/Time Camera register Channel setup

Number of Registered Channels: 0 / Number of Searched Cameras: 5

Model	IP Address	MAC Address	Status
WIS-8981S2	192.168.218.2	00:0B:30:52:0F:04	Success
WIS-8220	192.168.218.4	00:0B:30:52:0F:08	Success
WIS-8981S2	192.168.218.5	00:0B:30:52:0F:0A	Success
WIS-8981S2	192.168.218.6	00:0B:30:52:0F:0C	Success
WIS-8220	192.168.218.7	00:0B:30:52:0F:0D	Success

Camera to register

1CH 2CH 3CH 4CH 5CH 6CH 7CH 8CH 9CH 10CH 11CH 12CH 13CH 14CH 15CH 16CH 17CH 18CH 19CH 20CH 21CH 22CH

Change IP

Back Next

7 Channel Setting

You can view the camera videos registered to each channel in split mode along with thumbnail information. To change the camera video position, select a video and drag and drop it to the desired location.

Install Wizard

Language Network Recorder ID/PW Camera ID/PW Date/Time Camera register Channel setup

Select split mode, and then drag and drop to the desired position to set the channel.

1CH 2CH 3CH 4CH 5CH 6CH 7CH 8CH

9CH 10CH 11CH 12CH 13CH 14CH 15CH 16CH

17CH 18CH 19CH 20CH 21CH 22CH 23CH 24CH

25CH 26CH 27CH 28CH 29CH 30CH 31CH 32CH

33CH 34CH 35CH 36CH 37CH 38CH 39CH 40CH

41CH 42CH 43CH 44CH 45CH 46CH 47CH 48CH

49CH 50CH 51CH 52CH 53CH 54CH 55CH 56CH

57CH 58CH 59CH 60CH 61CH 62CH 63CH 64CH

Back Next

8 Click <Finish> to complete the Install Wizard.

Explore Screen Configuration

The recorder screen consists of the following.

- The screen may be configured differently depending on the menu selected by the user.

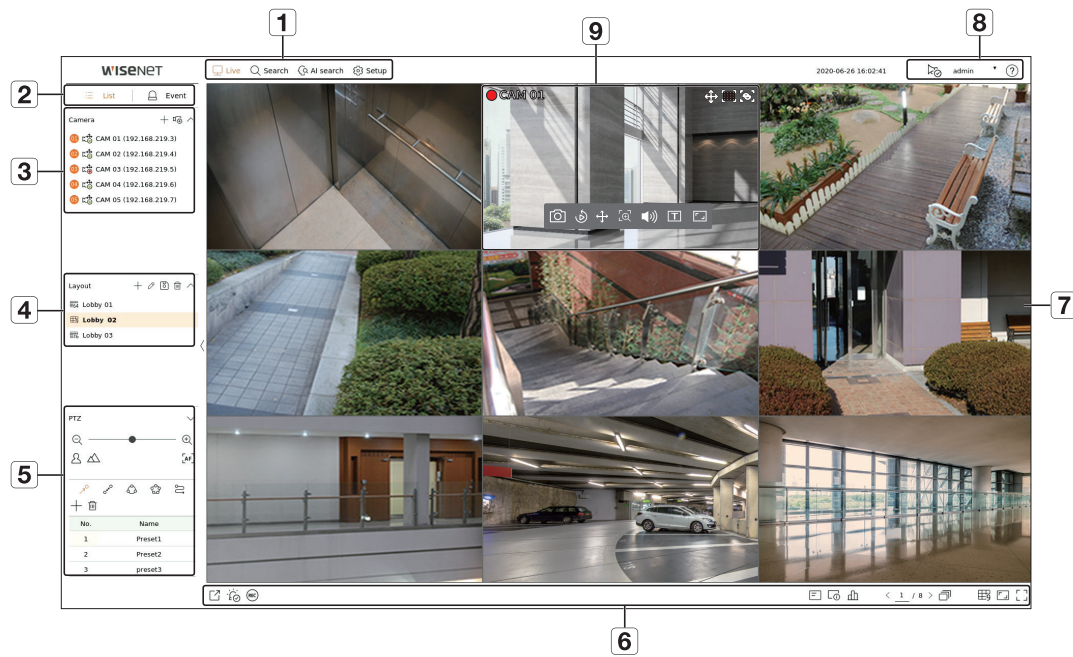

No.	Screen configuration	Detailed description of function
1	Menu	Clicking on each menu takes you to the corresponding menu screen.
2	Select list of device/event	Select to view list of cameras or events.
3	Device List	Click List to display list of registered cameras in the recorder. You can also register the camera manually or automatically.
	Event List	Click Event to display list of events.
4	Layout List	This displays a list of the default layouts and the layouts that have been created. You can set and play sequence on the list of layouts.
5	PTZ Control	Controls the connected PTZ camera.
6	Function buttons	Function that is frequently or urgently used. (export, alarm stop, manual recording, OSD display, channel information, check camera status, auto-switch screen, split mode setting, change aspect ratio, switch to full screen mode)
7	Video window	Shows the video of the camera connected to the recorder.
8	Display system status and additional functions	<ul style="list-style-type: none"> Displays the status of the system, hard disk, and network. The ID of the connected user is displayed. Displays a QR code to download User Manual.
9	Display events and functions to control videos	Displays events that occurred on the device and functions related to video control.

Record Setup

You can set resolution, FPS, and quality of recordings by channel, and by recording type of standard / event. You can check frame rates and data transfer amount of Full Frame and Key Frame recordings for each channel, and set the transfer limit for recordings.

Setup > Record > Record setup

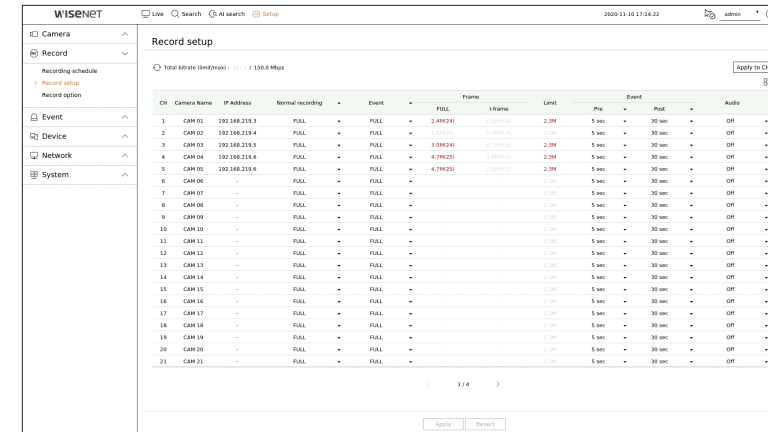

- Apply to CH : If you select **<Apply to CH>**, "Apply to CH" confirmation window will appear. After selecting channels that the settings will be applied to, click on **<OK>** to apply them to the selected channels.
- : The camera of the corresponding channel is displayed on the list or as a thumbnail.
- Camera name : Displays the camera name.
- IP Address : Displays the camera IP address.
- Normal recording, Event : Configures Standard recording and Event recording.
 - FULL : Records all frames fed by the camera.
 - I-frame : Records only key frames fed by the camera. Depends on camera settings.
 - OFF : No recording is made.
- Frame
 - FULL : Shows the amount of data for all the scene recordings.
 - I-frame : Shows the amount of data for the main scene recordings.
- Limit : Set the amount of data allowed for input for each channel.
- Event : When an event occurs, you can set which point you will start or stop recording.
 - Pre : When an event occurs, recording will be started regardless of the time set. If you set it to five seconds, recording will start at five seconds before an event occurs.
 - Post : When an event occurs, recording will continue after the time set. If you set it to five seconds, recording will continue for a further five seconds after an event is finished.
- Audio : Specify whether to record the sound received from the camera or not.

- If a channel's data transfer exceeds defined allowed limit, then it may affect to other channels, and may force switching to **<I-frame>** recording even when the channel is configured to **<FULL>** recording mode. For Key Frame recording channels, the icon for limited recording appears on the live screen's top side. But if the sum of the limits is below the max limit, you can still receive the entire frames despite exceeding the permitted bitrates for each channel.
- A channel displayed in yellow indicates that the recorded data is not being transferred from the camera and that the recording is being performed temporarily using another profile on the camera. Check the channel information to see the applied profile to the channel listed in yellow. A channel displayed in orange indicates that the amount of inputted data is greater than the permitted data amount. In this case, it is impossible to record all of the incoming frames. Instead, only part of the frames (1 or 2 frames per second) can be recorded. To resolve this issue, you must set the permitted data amount to be greater than the amount of inputted data.

Set up and Run the Layout

The layout set on the live screen can also be used for time search and can be searched and played according to the channel order and channel combination set by the user.

- For more information on how to set each step, refer to the 'User Manual'.

1 Live channel layout setup

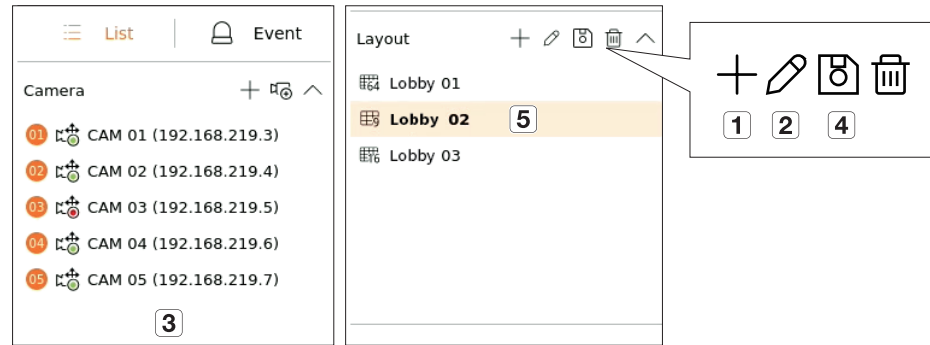

- Add a layout.
- Change layout name. (Example: Lobby 02)
- Click to select the channel to display on the layout of the device list.
- Please save the layout you have set up.
- Select a layout to move to the corresponding channel group. (Example: Move to Lobby 02).

2 Search/Play



- Click <Search> at the top of the screen.
- Click <Time Search>.

2-1 Search



- Select the layout of your choice from the channel groups you created in Live.
- Please select a date to search.
- Select the channel of your choice from the selected channel group.
- You can view the preview screen on figure 3 by moving the time bar.
- Press <▶> to play the selected channel.

2-2 Play

When you start playing, the search date and play time are displayed, and you can search for recorded videos while controlling the play speed.



- Control the play speed or move to the previous or next frame.
- Export the recorded video of a designated time frame for each layout or channel.
- Filter events by type to search for recorded videos.
- Set the overlapping section according to change of time to check the time line.
- Display the time line for each channel.
- Open or close the 4-channel time line.

3 Export recorded video



- 1 Click <☐> at the bottom of the screen.
- 2 Select a layout.
- 3 Select a channel.
- 4 Set the time, device, and format for export.
- 5 Click the <Check capacity> button to see if you can export.
- 6 Click the <Start> button to proceed with the export.

Using Product Information

You can check the product information/manual/firmware information/FAQ/HDD compatibility list on the homepage or mobile web of your smartphone.

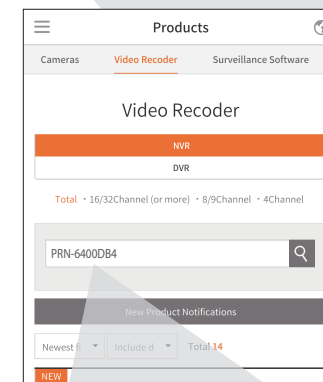
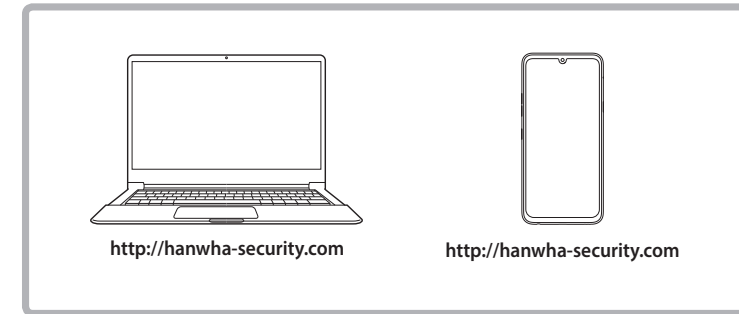

checkbox	category	file name	Last Updated
<input type="checkbox"/>	Manuals	User Manual- PRN-6400	2016-08-05
<input type="checkbox"/>	Manuals	User Manual- PRN-6400	2016-08-05
<input type="checkbox"/>	Certification	PRN-6400 C-TICK	2014-01-04
<input type="checkbox"/>	Certification	PRN-6400 FCC	2014-01-04
<input type="checkbox"/>	Certification	PRN-6400 VCCI	2014-01-04
<input type="checkbox"/>	Certification	PRN-6400 UL	2014-01-04
<input type="checkbox"/>	A&E Document	PRN-6400 A&E Doc...	2014-03-06
<input type="checkbox"/>	Firmware	PRN-6400 v2.14 16--	2016-07-01

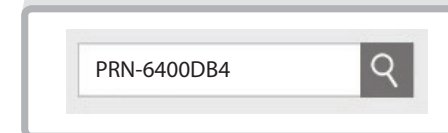

Using P2P Service

This function is available only for products that support P2P. To find products that support P2P, see **'Products supporting each feature (Page 4)'** of the Product Specification Manual.

When using a P2P service, you can easily access and use with Wisenet mobile.

- 1 Click **<Enable P2P>** to test the connection to see if the current recorder can be connected remotely. The product is displayed on the list.

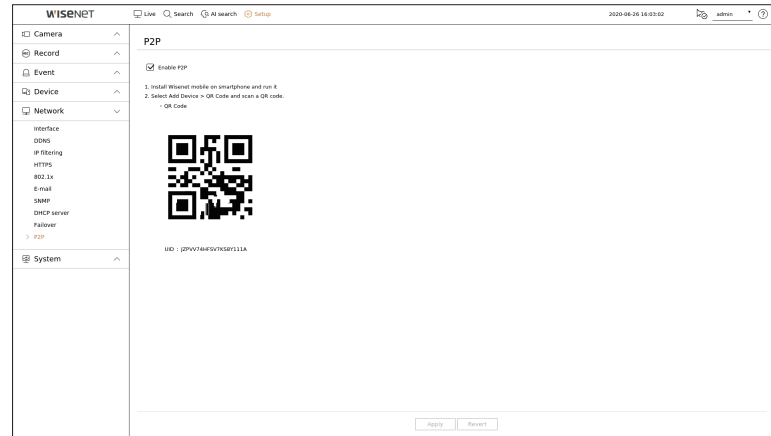

- 2 If the connection is successful, search for WiseNet mobile on your smartphone and install and run it.
 - You can scan the QR code on the recorder by selecting Add device> QR code.

- 3 If you scan the QR code, the device ID shown in the recorder is automatically reflected as the mobile viewer ID. You can use the mobile viewer immediately by entering the ID/password of the recorder.

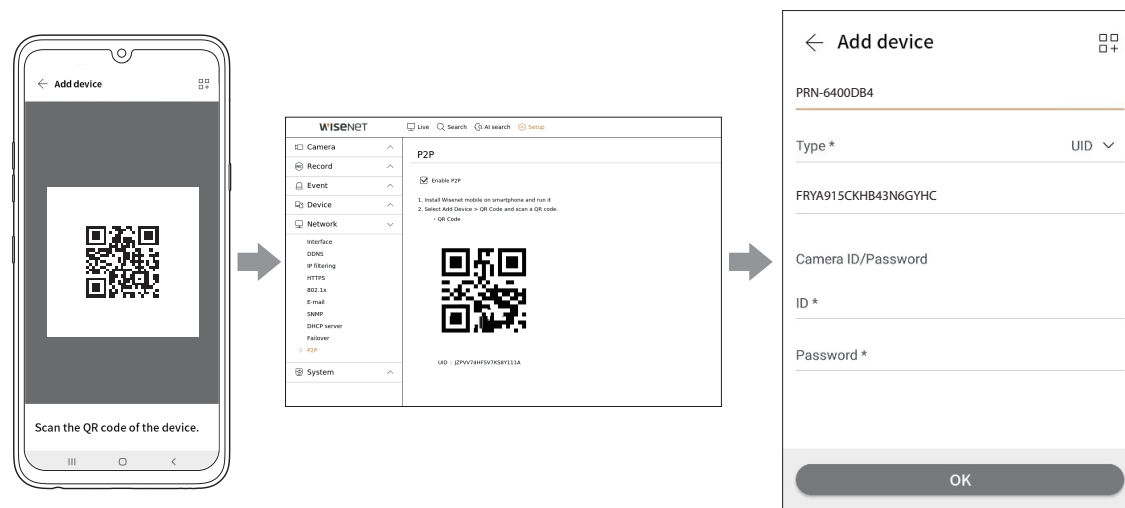

- 4 From now on, when you run the WiseNet mobile application saved to your smartphone, you can easily monitor with your smartphone as you are automatically connected to the recorder.

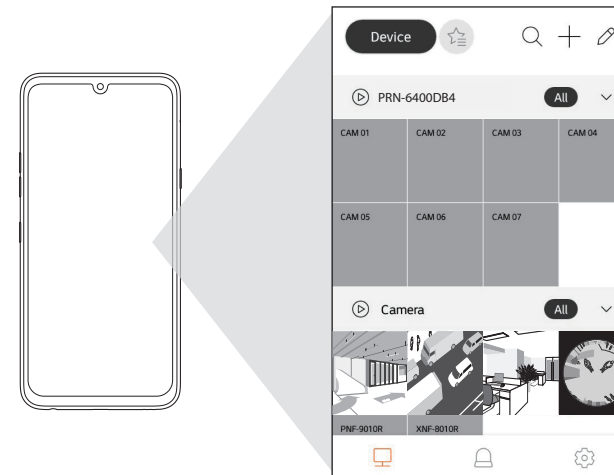

- The P2P service period expires in 3 years. If you want to extend it after expiration, contact your vendor.

Connecting to a Network Using a Router

If you want to add 1-3 PCs and recorders in an environment using xDSL/Cable modem, you can use the router with only one Internet line.

This guide is an installation guide for network beginners. Follow the instructions to set up your router, local PC, and recorder.

Connecting the cable

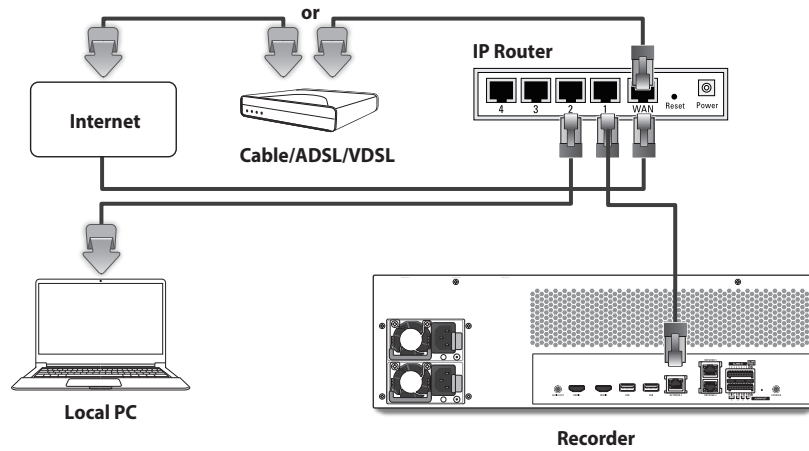

Connecting a router with PC

Refer to the router's user manual.

Connecting a recorder and a router

Move to **<Interface>** of the Recorder **<Network>** Setting menu, and set the **1 <IP Address>** and **2 <Gateway>** in **<Setup>**.

※ The **<Default Gateway>** checked on the **[cmd.exe]** window of the local PC and the **<Gateway>** of the recorder must be the same.

※ At least the third number of the recorder **<IP Address>** should be set to be the same as the **<Default Gateway>** checked on the **[cmd.exe]** window of the local PC.

```

Microsoft Windows [Version 10.0.18362.329]
(c) 2019 Microsoft Corporation. All rights reserved.

C:\Users\Users>ipconfig

Windows IP Configuration

Ethernet adapter Ethernet 2:

    Connection-specific DNS Suffix . : kornet
    IPv4 Address. . . . . : 192.168.219.125
    Subnet Mask . . . . . : 255.255.255.0
    Default Gateway . . . . . : 192.168.219.1
    
```

<cmd. screen>

<ex. Recorder screen>

Checking the recorder connection from the PC

Enter the IP set in the recorder menu in the local PC address bar to go to the web viewer screen of the recorder.

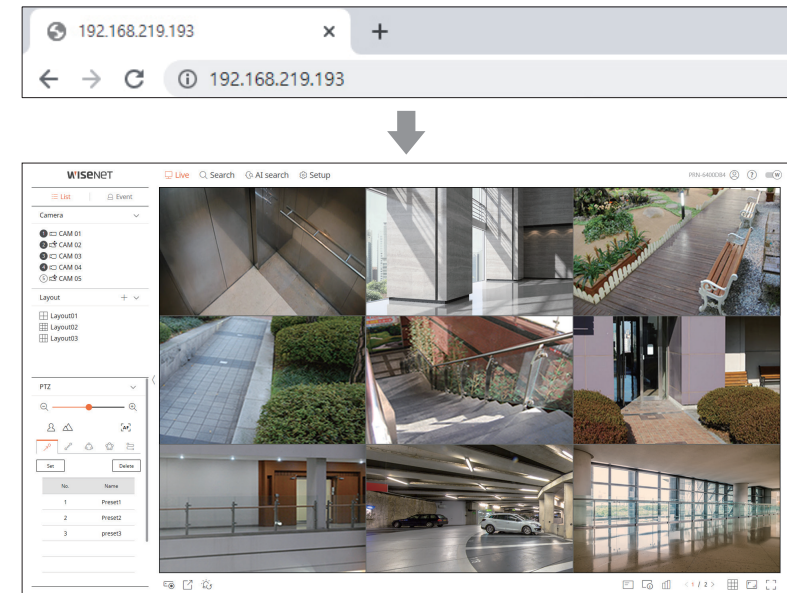

System requirements

The following lists the minimum suggested hardware and operating system requirements needed to run the Web Viewer.

- Recommended browser : Edge, Chrome
- Supported browsers : Chrome, Edge, and Safari
- Supported OS : Works on all of the Windows, Linux, and OS X environments given the platform-independent nature of the web.
- Tested environments : Tested and certified to run on Windows® 10 with Edge 83, Google Chrome™ 83 and Intel® Core™ i7-7700 processor 3.60 Ghz with NVIDIA® GeForce® GTX™ 1050 or Intel™ HD Graphics 630.
- Performance restrictions : The performance of users' CPU/GPU may impact the video playback performance of the web viewer.

Router and Internet connection setup

Since each router has a different connection method, check the settings for each router.

Port forwarding on the router setup

Set up the router's port forwarding to connect to a PC or a recorder connected to the router's local LAN from outside.

The recorder uses the **<RTSP port>**, **<HTTP>**, **<HTTPS>**, and camera proxy ports. You must set up port forwarding for all the ports you use.

- ※ If only **<HTTP port>** is set for port forwarding, **<RTSP port>**, which is a video transmission port, is connected, but no video is displayed.
- ※ If only **<RTSP port>** is set for port forwarding, no connection is available because **<HTTP port>**, which is a web connection port, is connected.
- ※ Refer to the router's user manual.

Accessing using DDNS address in the dynamic IP environment

In the dynamic IP environment such as xDSL/Cable modem, the router's WAN IP can be changed, so we provide DDNS (Dynamic Domain Name Server) service so that you can always access the recorder with only the DDNS address even in the dynamic IP environment.

Wisenet DDNS Setup

Since you will be accessing the recorder remotely, set up a Wisenet DDNS account first using a PC.

- 1 Open a browser, go to ddns.hanwha-security.com, and click <Login>.

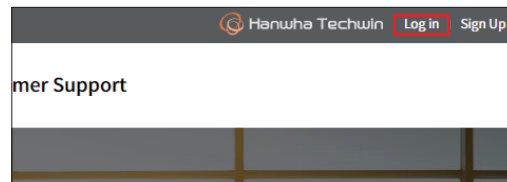

- 2 Click <Sign Up>.



- 1 Follow the instructions to register an account on the website.
- 2 Log in after completing account registration.

- 3 Click <Register Product> tab to add a recorder to your account.

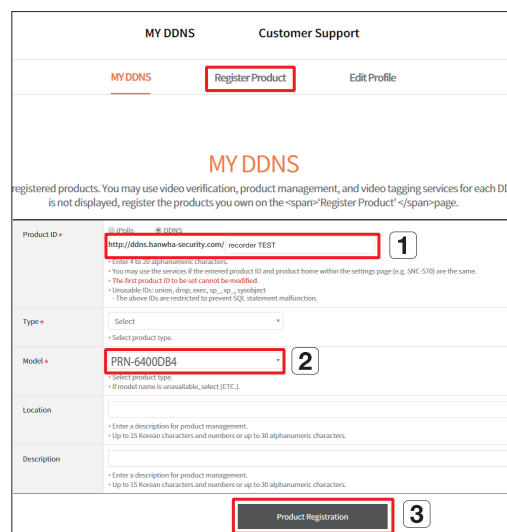

- 1 Create a name for your recorder (product ID).
- 2 Select the type of recorder and model name.
- 3 Click <Product Registration>.

- 4 After registration, your product will appear in the list.

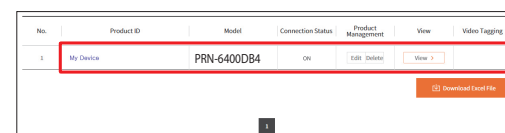

Connect using DDNS address

- 1 Select DDNS site on the recorder setup menu and enter the product ID.

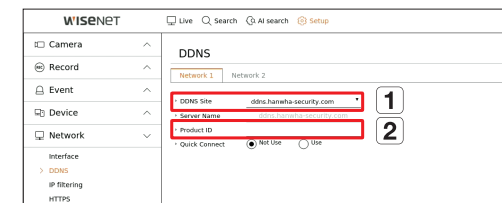

- 1 Select <ddns.hanwha-security.com> on the <DDNS site> on the <Network> menu.
- 2 Enter the product ID generated on the Wisenet DDNS website for <Product ID>.
- 3 When the DDNS setup is finished, select <Apply>.

- 3 You can connect to the recorder by entering the DDNS host address, <http://ddns.hanwha-security.com/recorder TEST>, on a local PC website address bar. You can also click <View > in item 2 to connect to the recorder.

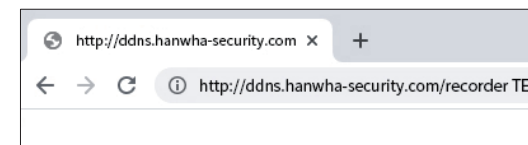

- 2 Connect to ddns.hanwha-security.com and check if the connection status of the registered product is set to <ON>.

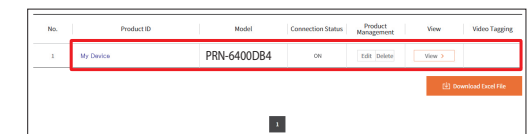

< Wisenet DDNS Setup screen >

- 4 The web viewer screen of the recorder appears.

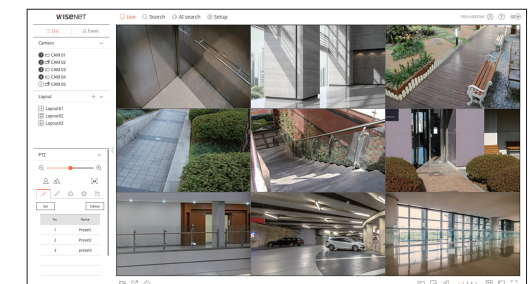

All settings are complete.

If you remember your DDNS address and ID / password, you can access the recorder from any PC with an Internet connection.

For more information, refer to the user manual.



Hanwha Techwin cares for the environment at all product manufacturing stages, and is taking measures to provide customers with more environmentally friendly products.
The Eco mark represents Hanwha Techwin's devotion to creating environmentally friendly products, and indicates that the product satisfies the EU RoHS Directive.

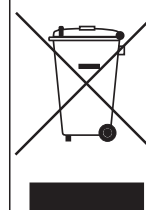

Correct Disposal of This Product (Waste Electrical & Electronic Equipment)

(Applicable in the European Union and other European countries with separate collection systems)

This marking on the product, accessories or literature indicates that the product and its electronic accessories (e.g. charger, headset, USB cable) should not be disposed of with other household waste at the end of their working life. To prevent possible harm to the environment or human health from uncontrolled waste disposal, please separate these items from other types of waste and recycle them responsibly to promote the sustainable reuse of material resources.

Household users should contact either the retailer where they purchased this product, or their local government office, for details of where and how they can take these items for environmentally safe recycling.

Business users should contact their supplier and check the terms and conditions of the purchase contract. This product and its electronic accessories should not be mixed with other commercial wastes for disposal.



Correct disposal of batteries in this product

(Applicable in the European Union and other European countries with separate battery return systems.)

This marking on the battery, manual or packaging indicates that the batteries in this product should not be disposed of with other household waste at the end of their working life. Where marked, the chemical symbols Hg, Cd or Pb indicate that the battery contains mercury, cadmium or lead above the reference levels in EC Directive 2006/66. If batteries are not properly disposed of, these substances can cause harm to human health or the environment.

To protect natural resources and to promote material reuse, please separate batteries from other types of waste and recycle them through your local, free battery return system.

