

AXIS P8815-2 3D People Counter

User Manual

AXIS P8815-2 3D People Counter

Solution overview

Solution overview

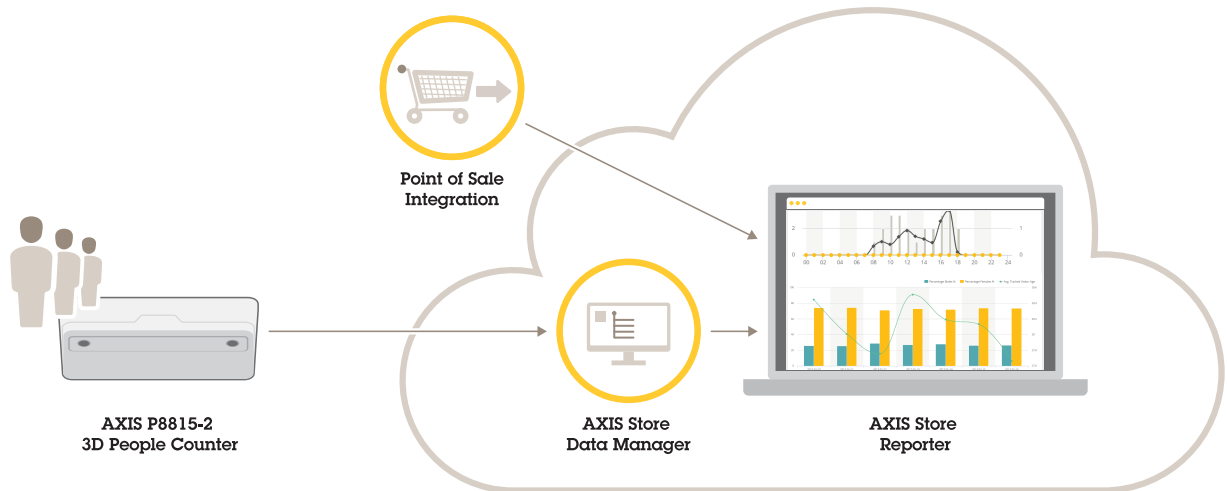

An overview of the different devices, applications, and tools needed for a complete Axis solution.

AXIS P8815-2 3D People Counter

AXIS P8815-2 3D People Counter provides software and dedicated hardware in one device. The 3D people counting application is embedded in the device. This means that you don't need a dedicated computer to run the application. AXIS P8815-2 3D People Counter is intended for indoor use in, for example, retail environments like stores or shopping malls, or other locations where you want to count people or keep track of how many people are inside the premises.

AXIS P8815-2 3D People Counter

Solution overview



An example of a store with AXIS P8815-2 3D People Counter at each entrance.

What's the difference between AXIS People Counter and AXIS P8815-2 3D People Counter?

The applications have two different algorithms for counting people which makes them suitable for different environments:

- AXIS People Counter recognizes objects that move in the field of view and identifies them as people based on their overall size and movement. AXIS People Counter is suitable for most scenarios, covering single as well as double door entrances.

AXIS P8815-2 3D People Counter

Solution overview

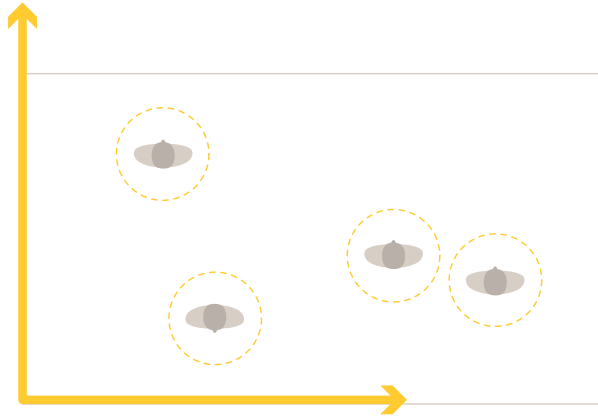

- AXIS P8815-2 3D People Counter calculates the depth within the counting area in order to measure the height and the size of the object. AXIS P8815-2 3D People Counter is suitable for crowded scenarios and scenes with challenging light conditions like strong sunlight, glares and shadows.

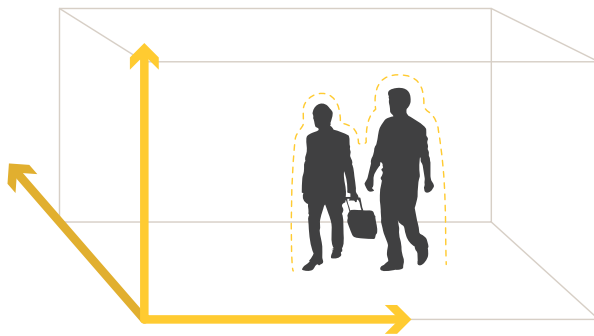

AXIS P8815-2 3D People Counter

Get started

Get started

To get started with AXIS P8815-2 3D People Counter:

1. Connect, find, and access the device: *Connect the device to the network on page 5 , Find the device on the network on page 6 , Access the device on page 6*
2. *Upgrade the firmware on page 7*
3. *Install the device on page 7*
4. *Configure the counter on page 11*

Connect the device to the network

You can connect the device to the network without removing it from the box:

1. Open the box.
2. Remove the front plate.
3. Open the lid.
4. Insert the network cable.

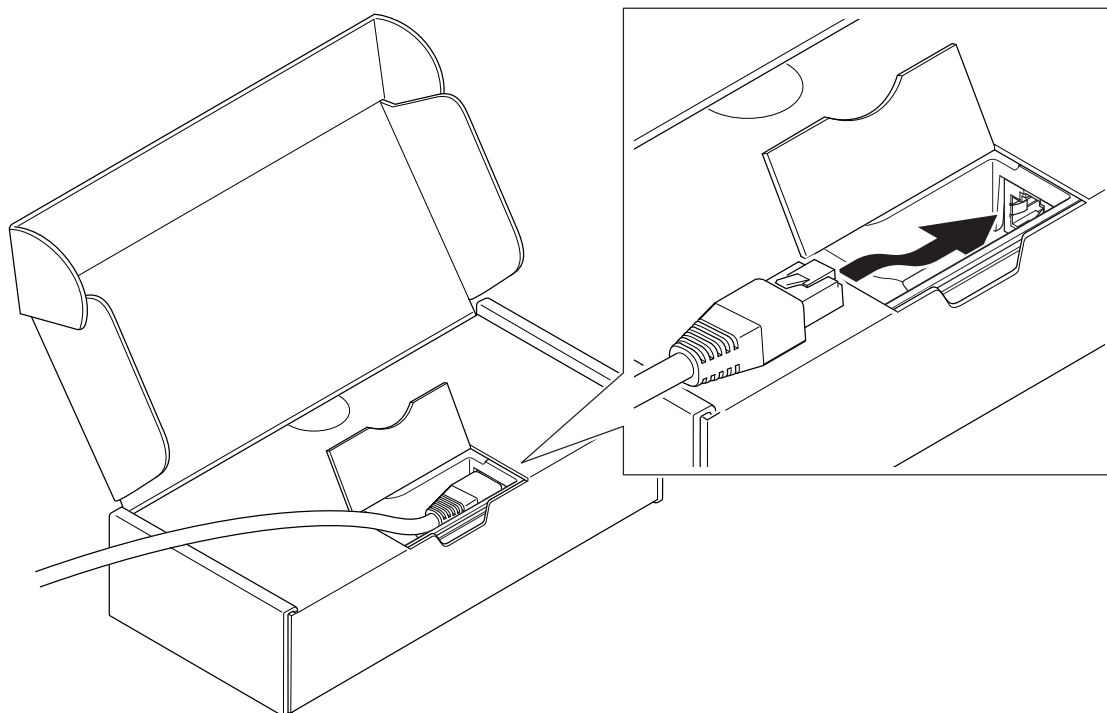

AXIS P8815-2 3D People Counter

Get started

Find the device on the network

To find Axis devices on the network and assign them IP addresses in Windows®, use AXIS IP Utility or AXIS Device Manager. Both applications are free and can be downloaded from axis.com/support.

For more information about how to find and assign IP addresses, go to *How to assign an IP address and access your device*.

Browser support

You can use the device with the following browsers:

	Chrome™	Firefox®	Edge®
Windows®	recommended	x	x
macOS®	recommended		
Other operating systems	x	x	

Access the device

1. Open a browser and enter the IP address or host name of the Axis device.
If you do not know the IP address, use AXIS IP Utility or AXIS Device Manager to find the device on the network.
2. Enter the username and password. If you access the device for the first time, you must set the root password. See *Set a new password for the root account on page 6*.
3. The live view page opens in your browser.

Verify that no one has tampered with the firmware

To make sure that the device has its original Axis firmware, or to take full control of the device after a security attack:

1. Reset to factory default settings. See *Reset to factory default settings on page 23*.
After the reset, secure boot guarantees the state of the device.
2. Configure and install the device.

Set a new password for the root account

Important

The default administrator username is **root**. If the password for root is lost, reset the device to factory default settings. See *Reset to factory default settings on page 23*



To watch this video, go to the web version of this document.

www.axis.com/products/online-manual/50535#t10098905

Support tip: Password security confirmation check

AXIS P8815-2 3D People Counter

Get started

1. Type a password. Follow the instructions about secure passwords. See *Secure passwords on page 7*.
2. Retype the password to confirm the spelling.
3. Click **Create login**. The password has now been configured.

Secure passwords

Important

Axis devices send the initially set password in clear text over the network. To protect your device after the first login, set up a secure and encrypted HTTPS connection and then change the password.

The device password is the primary protection for your data and services. Axis devices do not impose a password policy as they may be used in various types of installations.

To protect your data we strongly recommend that you:

- Use a password with at least 8 characters, preferably created by a password generator.
- Don't expose the password.
- Change the password at a recurring interval, at least once a year.

Upgrade the firmware

Before you start using the application, we recommend you to upgrade the firmware.

Note

When you upgrade the product with the latest firmware in the active track, the product receives the latest functionality available. Always read the upgrade instructions and release notes available with each new release before upgrading the firmware. To find the latest firmware and the release notes, go to axis.com/support/firmware.

1. Download the firmware file to your computer, available free of charge at axis.com/support/firmware.
2. Log in to the product as an administrator.
3. Go to **Device settings > Device view > System > Maintenance**. Follow the instructions under **Firmware upgrade**. When the upgrade has finished, the product restarts automatically.

You can use AXIS Device Manager for multiple upgrades. Find out more at axis.com/products/axis-device-manager.

Install the device

For instructions on how to install the device, see the installation guide and the installation video.



Installation guide

AXIS P8815-2 3D People Counter

Get started



To watch this video, go to the web version of this document.

www.axis.com/products/online-manual/50535#t10098481

Installation video

In addition to the instructions in the installation guide, there are some important steps to follow for the application to behave in the expected way:

- The device must be mounted straight above the point where people pass.

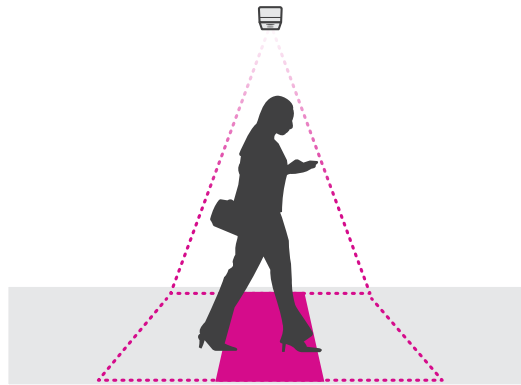

- Make sure the device is facing straight down, in line with the ceiling. It's important that both the ceiling and the floor are level.

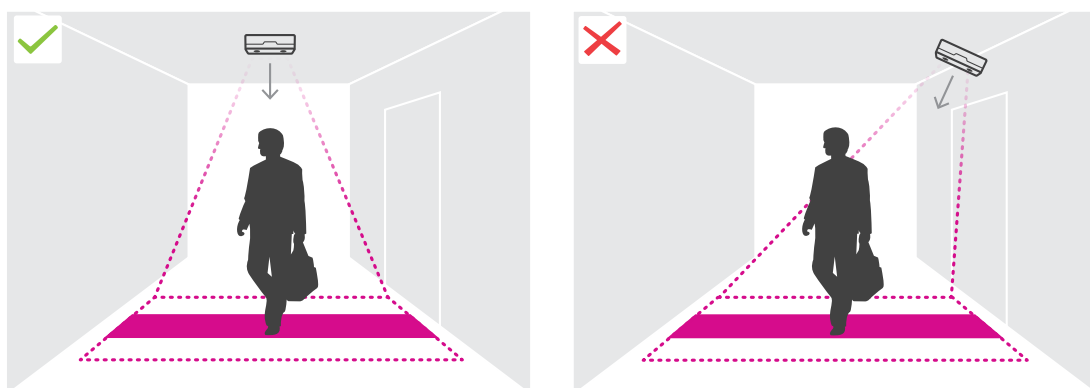

- Make sure there is sufficient white light on site.

AXIS P8815-2 3D People Counter

Get started

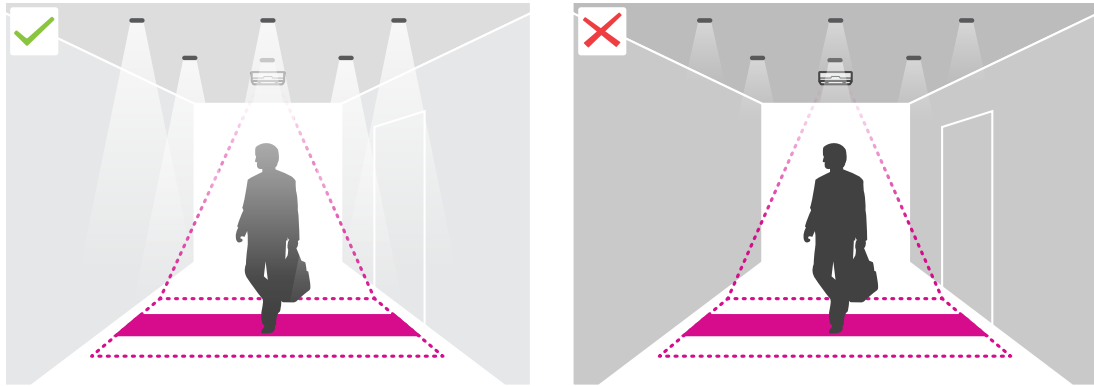

- Make sure there are no objects interfering in the device's view. For example, do not install the device too close to a door or a large sign hanging from the ceiling.

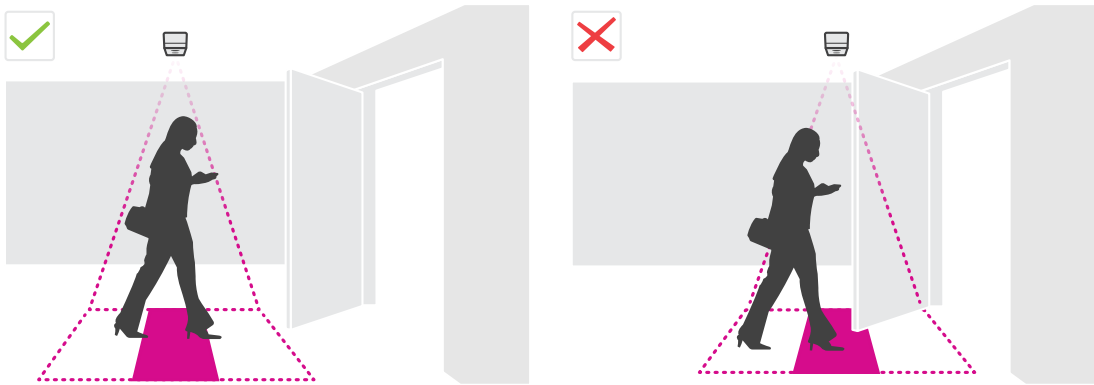

- Loitering people or large objects that sway slightly could interfere with the counting.

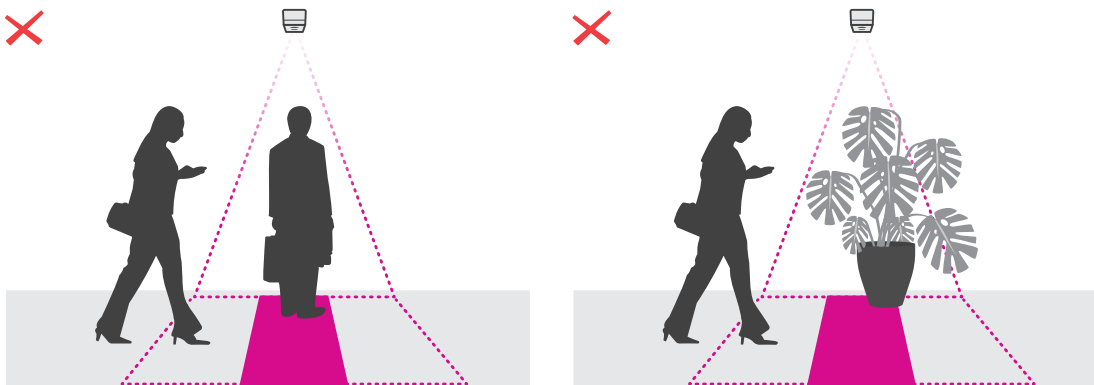

Mounting height and coverage

The table shows the maximum width and depth that can be covered by a single device at a given mounting height. The mounting height is the distance from the floor to the back of the device. If your area of interest is wider than the maximum counting area width, you can mount more than one device to cover the full width. To calculate how many devices you need, use the *design tool for AXIS P8815-2 3D People Counter*.

AXIS P8815-2 3D People Counter

Get started

Mounting height cm (in)	Maximum counting area width cm (in)	Maximum counting area depth cm (in)
250 (98)	199 (78)	46 (18)
300 (118)	306 (120)	100 (39)
350 (138)	400 (157)	154 (61)
400 (157)	400 (157)	208 (82)
450 (177)	400 (157)	225 (89)
500 (197)	400 (157)	225 (89)
550 (217)	400 (157)	225 (89)
600 (236)	400 (157)	225 (89)

AXIS P8815-2 3D People Counter

Configure the counter

Configure the counter

If the area of interest can be covered by a single device, follow the instructions in *Configure a single device on page 11*

If the area of interest is too wide to be covered by a single device, you can connect multiple devices to increase the width of the counting area. For a multiple device setup, follow the instructions in *Configure multiple devices on page 12*

Counting area

The counting area is the area where people who pass through are counted. You draw the counting area at floor level. Entrance lines are green and marked with an arrow, and exit lines are blue. To be counted as going in, a person has to cross first an entrance and then an exit line. To be counted as going out, a person has to cross first an exit line and then an entrance line.

Important



If the scene is a corridor, make sure the counting area doesn't include parts of the walls as this can cause problems with shadows being counted.

Configure a single device



To watch this video, go to the web version of this document.

www.axis.com/products/online-manual/50535#t10156684

1. Measure the device's mounting height.
The mounting height is the distance from the floor to the back of the device.
2. In the device's webpage, go to **Setup > Counter** and make sure **Single device** is highlighted.
3. Fill in the device's name and mounting height in the **Device** section.
4. Create the counting area:
 - 4.1 Click  .
 - 4.2 Click the live image once for every corner of the counting area.
The counting area must consist of at least 4 corners.
5. Set entrance and exit segments of the counting area:
 - 5.1 Click  .
 - 5.2 Click each entrance segment of the counting area.
 - 5.3 Click  .

AXIS P8815-2 3D People Counter

Configure the counter

5.4 Click each exit segment of the counting area.

Entrance segments are green, and exit segments are blue.

6. Click **Save**.

7. Go to **Advanced > Troubleshooting** and turn off **Application in test mode**.

Configure multiple devices



To watch this video, go to the web version of this document.

www.axis.com/products/online-manual/50535#t10156683

Important

For reporting of statistics to work, the date and time must be synchronized between the devices. We recommend you to use an NTP server to keep the devices synchronized.

1. Measure the device's mounting height.

The mounting height is the distance from the floor to the back of the device.

Important

All devices must be mounted at the same height.

2. Open the primary and secondary devices' webpages in separate tabs in a web browser.
3. In the webpage of the primary device, go to **Setup > Counter** and select **Multiple device**.
4. Under **Wide area coverage**, make sure **Primary** is highlighted.
5. In **Preferred URL**, enter a name or address that the secondary device can always use to connect to the primary device. You need to enter a value if, for example, you connect to the devices through a proxy, or if the devices get their IP addresses assigned dynamically. If the value is already correct, you don't need to change anything.
6. Click **Generate key** to generate a key for the primary device.
7. Copy the primary key.
8. Fill in the device's name and mounting height in the **Device** section.
9. In the webpage of the secondary device, go to **Setup > Counter** and select **Multiple device**.
10. Under **Wide area coverage**, select **Secondary**.
11. Paste the primary key into the **Primary key** field and click **Test connection**.
12. Fill in the device's name and mounting height in the **Device** section.
13. Click **Save**.

AXIS P8815-2 3D People Counter

Configure the counter

14. In the webpage of the primary device, enter the URL of the secondary device in **Secondary URL**.
15. Place an object, for example a sheet of paper, at the exact mid-point between the two devices. It's very important that you place the object exactly in the middle of the two devices since the object is used as a reference point to calibrate the devices.
16. Use the sliders to align the devices' views. Try to avoid vertical offset.

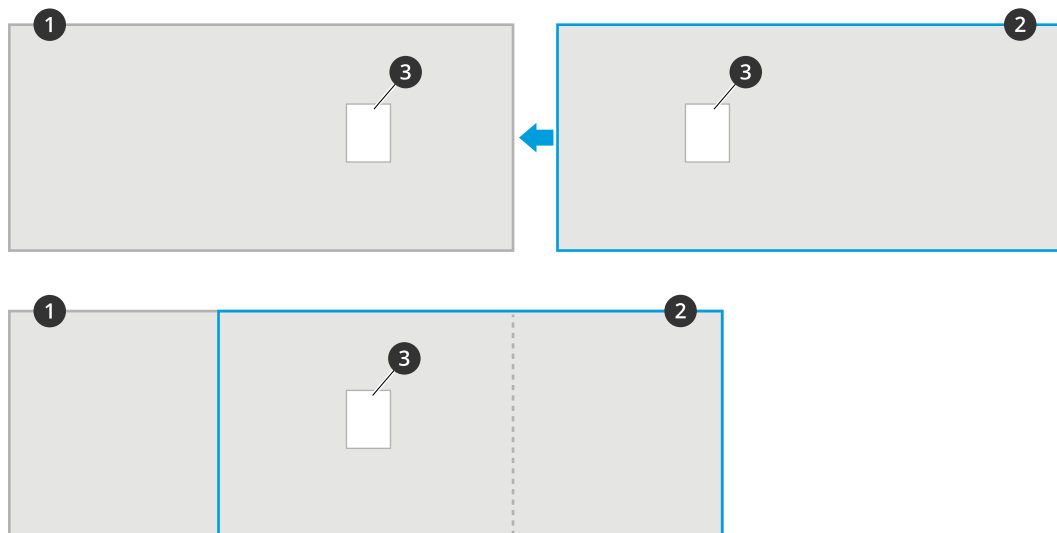

- 1 Primary device's view
- 2 Secondary device's view
- 3 Reference object

17. To change which side of the counting area is the entrance and exit, click **Reverse in/out direction** under **Counting area**.
18. Click **Save**.
19. Go to **Advanced > Troubleshooting** and turn off **Application in test mode**.

AXIS P8815-2 3D People Counter

Additional settings

Additional settings

Create a user account

You can create user accounts with different privileges, so that unauthorized staff can view statistics but not change any settings of the counter.

To create a user account:

1. Go to **Device settings > Users**.
2. Click **+**.

Users with the **Viewer** role can only access the **Statistics** tab. For more information about different user roles, see the built-in help.

Anonymize people

Note

This setting is only available if you have logged in as an administrator.

If you want to prevent people from being identified in the live view or recordings, you can turn on privacy mode. Privacy mode blocks all video streams and images and turns the live view into a black image.

To turn on privacy mode:

1. Go to **Setup > Counter > Privacy**.
2. Turn on **Privacy mode**.

Notify user every time a defined number of people have entered a room

With the passthrough threshold functionality, you can get notified every time a certain number of people have passed the counter. You can use it, for example, to know when it's time to clean a room. The feature only counts people going in. When the defined number has been reached, the passthrough counter starts over from 0.

This example explains how to set up a rule to send an email every time 100 people have entered a room that has a counter outside the entrance.

Set the passthrough threshold

1. In the device's webpage, go to **Setup > Counter > Passthrough threshold**.
2. Turn on **Allow passthrough threshold events**.
3. In **Number of IN passages between events**, enter **100**.
4. Click **Save**.

Create a rule

1. Go to **Device view > Events > Rules** and add a rule.
2. Type a name for the rule.
3. In the list of conditions, under **Application**, select **A3DPCPassthroughThresholdEvent**.
4. In the list of actions, under **Notifications**, select **Send notification to email** and then select a recipient from the list.

To create a new recipient, go to **Recipients**.

AXIS P8815-2 3D People Counter

Additional settings

5. Type a subject and a message for the email.
6. Click **Save**.

Occupancy estimation

The occupancy estimation functionality estimates how many people are inside the premises at the same time. It works when there is just one entrance as well as when there are several entrances. For areas with more than one entrance, you need to install AXIS P8815-2 3D People Counter devices at each one. You connect the devices to each other, and assign the primary occupancy role to one of them and the secondary occupancy role to the other ones. The primary occupancy device continuously receives data from the secondary occupancy devices and presents the data in the **Statistics** tab.

Note

The primary and secondary occupancy roles are different from the primary and secondary roles that are used to connect devices to increase the counting area width to cover wide entrances. Read more in *Mounting height and coverage on page 9*.

Configure occupancy estimation for a single entrance area

If there is only one way in and out of the area, you simply need to turn on the occupancy functionality. If the entrance is covered by multiple devices, turn on the functionality in the primary device.

1. Go to **Setup > Occupancy** and turn on **Estimate occupancy**.

Configure occupancy estimation for a multiple entrance area

If there is more than one way in and out of the area, you need to connect the devices from all entrances and exits and give one of them the primary occupancy role. The other devices take the secondary occupancy role. If an entrance is wide and therefore covered by multiple devices, you only need to connect the wide area coverage primary device.

The primary occupancy device receives data from all devices connected to it.



To watch this video, go to the web version of this document.

www.axis.com/products/online-manual/50535#t10162937

1. Select one device to be the primary occupancy device. It doesn't matter which device you choose.
2. Open the primary and secondary occupancy devices' webpages in separate tabs in a web browser.
3. In the webpage of the primary occupancy device, go to **Setup > Occupancy** and turn on **Estimate occupancy**.
4. Under **Occupancy role**, select **Primary**.
5. If the preferred URL is wrong, change it.
6. Generate keys for all secondary occupancy devices.
7. Copy one of the keys.
8. In the webpage of one of the secondary occupancy devices, go to **Setup > Occupancy** and turn on **Estimate occupancy**.

AXIS P8815-2 3D People Counter

Additional settings

9. Under **Occupancy** role, select **Secondary**.
10. Paste the key and click **Test connection**.
11. Repeat steps 7-10 for each of the secondary occupancy devices. Use unique keys for each device.

You can generate new keys whenever you need to.

Change time for occupancy reset

Note

We recommend you to reset the occupancy value when the premises are normally empty, for example during closing hours just before opening time.

By default, the occupancy value resets once per day at 00:00. To change the time of the reset to 06:30:

1. Go to **Setup > Occupancy**.
2. Move the **Occupancy reset** slider to 6:30:00 AM.

Send an email when the occupancy level exceeds the limit

This example explains how to set up a rule to send an email when the number of people inside the premises exceeds a limit. In the example, the limit is 200.

Set the maximum occupancy limit

1. In the device's webpage, go to **Setup > Occupancy**.
2. Under **Allow events**, enter **200** in **Higher threshold**.

Create a rule

1. Go to **Device view > Events > Rules** and add a rule.
2. Type a name for the rule.
3. In the list of conditions, under **Application**, select **A3DPCOccupancyEvent-High**.
4. In the list of actions, under **Notifications**, select **Send notification to email** and then select a recipient from the list.
To create a new recipient, go to **Recipients**.
5. Type a subject and a message for the email.
6. Click **Save**.

Send a notification when the occupancy limit is exceeded

This example explains how to set up a rule in AXIS Camera Station to send mobile notifications when the number of people inside the premises exceed the maximum limit. In the example, the maximum limit is 50.

Before you start

You need:

- occupancy turned on and configured in the device
- a computer with AXIS Camera Station 5.36 or later installed
- AXIS Camera Station Mobile app

Set the maximum occupancy limit

AXIS P8815-2 3D People Counter

Additional settings

1. In the device's webpage, go to **Setup > Occupancy**.
2. Under **Allow events**, enter **50** in **Higher threshold**.

Create a device event trigger

1. In AXIS Camera Station, click **+** and go to **Configuration > Recording and events > Action rules** and click **New**.
2. Click **Add** to add a trigger.
3. Select **Device event** from the list of triggers and click **Ok**.
4. In the **Configure device event trigger** section:
 - In **Device**, select the device.
 - In **Event**, select **A3DPCOccupancyEvent-High**.
 - In **Trigger period**, set an interval time between two successive triggers. Use this function to reduce the number of successive recordings. If an additional trigger occurs within this interval, the event will continue and the trigger period starts over from that point in time.
5. In **Filters**, set active to **Yes**.
6. Click **Ok**.

Create actions to send notifications to the mobile app

1. Click **Next**.
2. Click **Add** to add an action.
3. Select **Send mobile app notification** from the list of actions and click **Ok**.

Note

The message is what the receiver sees when an alarm is triggered.

4. In **Message**, enter the message to send when the occupancy limit is exceeded.
5. Select **Default**. This opens the main page of the AXIS Camera Station Mobile app when the receiver clicks the notification.
6. Click **Ok**.

Specify when the alarm is active

1. Click **Next**.
2. If you only want the alarm to be active during certain hours, select **Custom schedule**.
3. Select a schedule from the list.
4. Click **Next**.
5. Enter a name for the rule.
6. Click **Finish**.

Occupancy status pages

If you want to visualize the current occupancy level to an operator or directly to customers, you can use the occupancy status pages.

- <http://<servername>/a3dpc/index.html#/occupancy-operator-view>: The page shows how many people are currently in the premises, and whether that number is low, medium, or high occupancy. Go to **Setup > Occupancy > Events** to define the thresholds.

AXIS P8815-2 3D People Counter

Additional settings

- <http://<servername>/a3dpc/index.html#/occupancy-stop-go>: The page shows visitors if they can enter the premises or not. If the estimated occupancy is low or medium, visitors are welcome to enter. Go to **Setup > Occupancy > Events** to define the thresholds.

You can embed these pages into other systems, for example AXIS Camera Station or Milestone's XProtect Smart Client. For instructions on how to embed a page into AXIS Camera Station, see the *user manual for AXIS Camera Station*.

AXIS P8815-2 3D People Counter

Integration

Integration

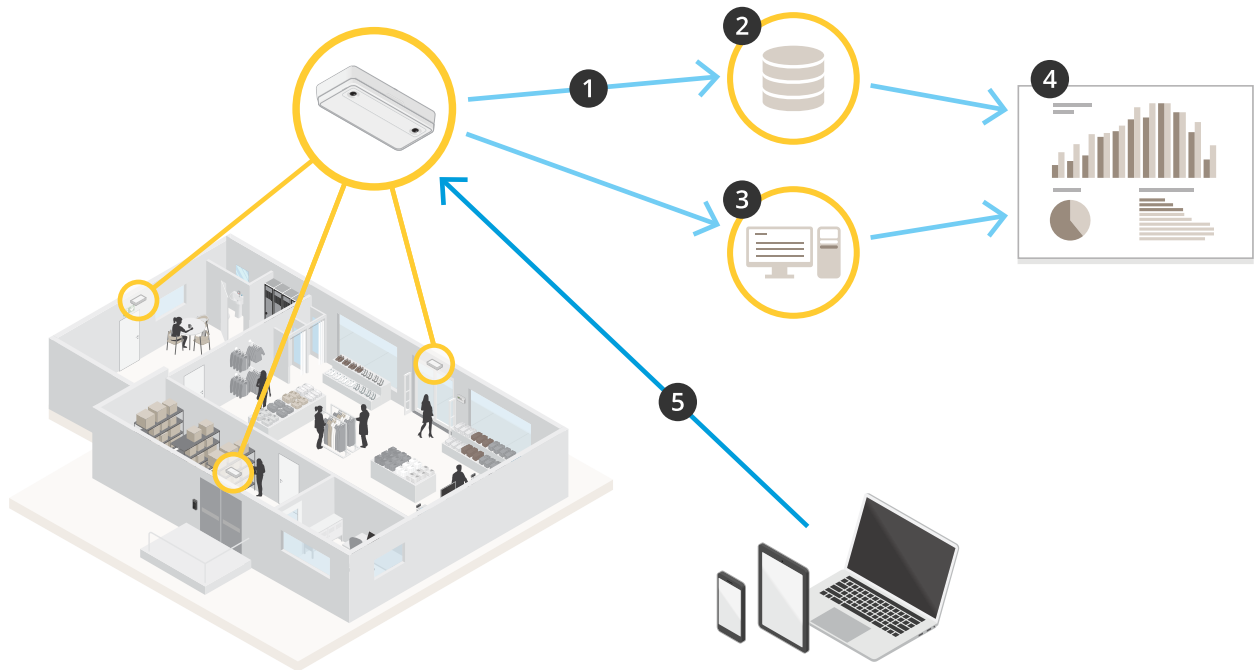

1. The device sends data automatically to a remote HTTPS destination through the data push functionality.
2. A third-party database or service stores and processes the data.
3. Alternatively, the device sends data to a local instance of AXIS Store Data Manager, which stores and processes the data.
4. AXIS Store Reporter, or a third-party reporting platform, visualizes the collected data.
5. Alternatively, third-party applications request data directly from the device through a built-in API.

Statistics

There are several ways to use the statistics from the counter:

- In the application's webpage, view real-time counting data in the built-in graphs.
- View built-in graphs in day, week, and month views in the statistics page. The data is updated in real time.
Data is available on the device for up to 90 days and updated every minute. The data is stored in one-minute bins representing the in and out counts for that minute.
- Download data through an open API. See *API documentation*
- Send data automatically to a remote HTTPS destination through the data push functionality. See *Report data to a remote destination on page 20*.
- Use AXIS Store Data Manager, a software package that acts as a central point to store and manage data collected from all devices. See *Connect the device to a folder in AXIS Store Data Manager on page 20*.
- Use AXIS Store Reporter, a statistical web-based solution, for managing and monitoring historical data.
- Download statistics to your computer, see *Download statistics on page 21*.

AXIS P8815-2 3D People Counter

Integration

Connect the device to a folder in AXIS Store Data Manager

1. In AXIS Store Data Manager, go to **Sources** and get the **Folder connection identifier** and the **Folder connection password** for the folder you want to connect to.
2. In the application's webpage, go to **Setup > Counter**.
3. Under **Device**, enter a name for the device, so you know which device the report comes from.
4. Go to **Setup > Reporting**.
5. To allow sending reports to AXIS Store Data Manager, turn on **Report to ASDM**.
6. In the **URL** field, enter the address to the server.
7. Enter the folder connection identifier and password for AXIS Store Data Manager in the **Folder identifier** fields.
8. Click **Test connection**.
If the connection is successful, it's indicated by a white check mark.
9. Click **Save**.

Report data to a remote destination

To make the device push data regularly to a remote destination:

1. Go to **Setup > Counter** and check that the device has a name.
The name helps you identify which device the report comes from.
2. Go to **Setup > Reporting** and turn on **Report to server**.
3. In the **URL** field, enter the address of the server, for example `https://example.com/server`.
4. In the **Send interval** field, set how often you want the device to send data to the server.
5. Optionally, enter a token to let the device authenticate itself to the server in the **API token** field.
6. Click **Test connection**.
If the connection is successful, it's indicated by a white check mark.
7. Click **Save**.

You can learn more about the data push functionality in the *API documentation*.

Configure proxy settings

If the device and the report destination are separated by a proxy server, you need to enter information about the proxy server in the device's webpage to be able to send reports.

1. Go to **Setup > Reporting** and turn on **Use proxy**.
2. In the **URL** field, enter the address of the proxy server followed by a port number if applicable. For example: `https://example.com/proxy:3128`.
3. In the **Username** and **Password** fields, enter the username and password of the proxy server.
4. Click **Save**.

AXIS P8815-2 3D People Counter

Integration

Download statistics

1. Go to **Statistics**.
2. Click **Export data**.

A comma-delimited (.csv) file with all statistics data from the device is saved locally.

AXIS P8815-2 3D People Counter

Troubleshooting

Troubleshooting

Issue	Action
The software doesn't count.	Make sure the instructions for how to install the device has been followed, see <i>Install the device on page 7</i> .
I still can't get the software to count.	If you have followed the advice above and still can't get the software to work, contact your Axis reseller.
The software counts shadows on the walls.	<ol style="list-style-type: none">1. Make sure the counting area only doesn't include parts of the walls.2. Go to Advanced > Troubleshooting and turn on Eliminate shadows.
I have a wide area covered by multiple devices, and the software doesn't send reports.	Make sure the date and time of the devices are synchronized.
The software warns me that the FPS is low.	<ol style="list-style-type: none">1. Make sure no other applications run on the device at the same time.2. Make sure there is only one video stream from the device running at a time.

Technical issues, clues, and solutions

Problems upgrading the firmware

Firmware upgrade failure If the firmware upgrade fails, the device reloads the previous firmware. The most common reason is that the wrong firmware file has been uploaded. Check that the name of the firmware file corresponds to your device and try again.

Problems setting the IP address

The device is located on a different subnet If the IP address intended for the device and the IP address of the computer used to access the device are located on different subnets, you cannot set the IP address. Contact your network administrator to obtain an IP address.

The IP address is being used by another device Disconnect the Axis device from the network. Run the ping command (in a Command/DOS window, type `ping` and the IP address of the device):

- If you receive: `Reply from <IP address>: bytes=32; time=10...` this means that the IP address may already be in use by another device on the network. Obtain a new IP address from the network administrator and reinstall the device.
- If you receive: `Request timed out`, this means that the IP address is available for use with the Axis device. Check all cabling and reinstall the device.

Possible IP address conflict with another device on the same subnet The static IP address in the Axis device is used before the DHCP server sets a dynamic address. This means that if the same default static IP address is also used by another device, there may be problems accessing the device.

AXIS P8815-2 3D People Counter

Troubleshooting

The device cannot be accessed from a browser

Cannot log in	<p>When HTTPS is enabled, ensure that the correct protocol (HTTP or HTTPS) is used when attempting to log in. You may need to manually type <code>http</code> or <code>https</code> in the browser's address field.</p> <p>If the password for the user <code>root</code> is lost, the device must be reset to the factory default settings. See <i>Reset to factory default settings on page 23</i>.</p>
The IP address has been changed by DHCP	<p>IP addresses obtained from a DHCP server are dynamic and may change. If the IP address has been changed, use AXIS IP Utility or AXIS Device Manager to locate the device on the network. Identify the device using its model or serial number, or by the DNS name (if the name has been configured).</p> <p>If required, a static IP address can be assigned manually. For instructions, go to axis.com/support.</p>

Problems with streaming

Multicast H.264 only accessible by local clients	<p>Check if your router supports multicasting, or if the router settings between the client and the device need to be configured. The TTL (Time To Live) value may need to be increased.</p>
No multicast H.264 displayed in the client	<p>Check with your network administrator that the multicast addresses used by the Axis device are valid for your network.</p> <p>Check with your network administrator to see if there is a firewall preventing viewing.</p>
Poor rendering of H.264 images	<p>Ensure that your graphics card is using the latest driver. The latest drivers can usually be downloaded from the manufacturer's website.</p>
Color saturation is different in H.264 and Motion JPEG	<p>Modify the settings for your graphics adapter. Go to the adapter's documentation for more information.</p>
Lower frame rate than expected	<ul style="list-style-type: none">• See <i>Performance considerations on page 24</i>.• Reduce the number of applications running on the client computer.• Limit the number of simultaneous viewers.• Check with the network administrator that there is enough bandwidth available.• Lower the image resolution.• The maximum frames per second is dependent on the utility frequency (60/50 Hz) of the Axis device.

Restart the application

If the counting is inaccurate or the web interface unusually slow, you can try restarting the running services or restart the device.

To restart the device, go to **Device Settings > Device view > System > Maintenance** and click **Restart**.

Generate a log report

If you have any trouble with your device you can generate a log report.

1. Go to **Device settings > Device view > System > Maintenance > Logs**
2. Click **View the system log**.
3. The log report opens in a new tab in the browser.

Reset to factory default settings

Important

Reset to factory default should be used with caution. A reset to factory default resets all settings, including the IP address, to the factory default values. It also deletes all counting data from the device.

AXIS P8815-2 3D People Counter

Troubleshooting

1. Disconnect power from the product.
2. Press and hold the control button while reconnecting power. See *Product overview on page 26*.
3. Keep the control button pressed for 15–30 seconds until the status LED indicator flashes amber.
4. Release the control button. The process is complete when the status LED indicator turns green. The product has been reset to the factory default settings. If no DHCP server is available on the network, the default IP address is 192.168.0.90.
5. Use the installation and management software tools to assign an IP address, set the password, and access the video stream.

The installation and management software tools are available from the support pages on axis.com/support.

It is also possible to reset parameters to factory default through the web interface. Go to **Device settings > Device view > System > Maintenance**.

Firmware options

Axis offers product firmware management according to either the active track or the long-term support (LTS) tracks. Being on the active track means continuously getting access to all the latest product features, while the LTS tracks provide a fixed platform with periodic releases focused mainly on bug fixes and security updates.

Using firmware from the active track is recommended if you want to access the newest features, or if you use Axis end-to-end system offerings. The LTS tracks are recommended if you use third-party integrations, which are not continuously validated against the latest active track. With LTS, the products can maintain cybersecurity without introducing any significant functional changes or affecting any existing integrations. For more detailed information about Axis product firmware strategy, go to axis.com/support/firmware.

Check the current firmware

Firmware is the software that determines the functionality of network devices. One of your first actions when troubleshooting a problem should be to check the current firmware version. The latest version may contain a correction that fixes your particular problem.

To check the current firmware, go to **Advanced > About**.

Performance considerations

When setting up your system, it is important to consider how various settings and situations affect the performance. Some factors affect the amount of bandwidth (the bitrate) required, others can affect the frame rate, and some affect both. If the load on the CPU reaches its maximum, this also affects the frame rate.

The following factors are the most important to consider:

- High image resolution or lower compression levels result in images containing more data which in turn affects the bandwidth.
- Rotating the image in the GUI will increase the product's CPU load.
- Access by large numbers of Motion JPEG or unicast H.264 clients affects the bandwidth.
- Simultaneous viewing of different streams (resolution, compression) by different clients affects both frame rate and bandwidth.

Use identical streams wherever possible to maintain a high frame rate. Stream profiles can be used to ensure that streams are identical.

- Accessing Motion JPEG and H.264 video streams simultaneously affects both frame rate and bandwidth.
- Heavy usage of event settings affects the product's CPU load which in turn affects the frame rate.
- Using HTTPS may reduce frame rate, in particular if streaming Motion JPEG.

AXIS P8815-2 3D People Counter

Troubleshooting

- Heavy network utilization due to poor infrastructure affects the bandwidth.
- Viewing on poorly performing client computers lowers perceived performance and affects frame rate.
- Running multiple AXIS Camera Application Platform (ACAP) applications simultaneously may affect the frame rate and the general performance.

Need more help?

Useful links

- *How to assign an IP address and access your device*

Contact support

Contact support at axis.com/support.

AXIS P8815-2 3D People Counter

Specifications

Specifications

Product overview

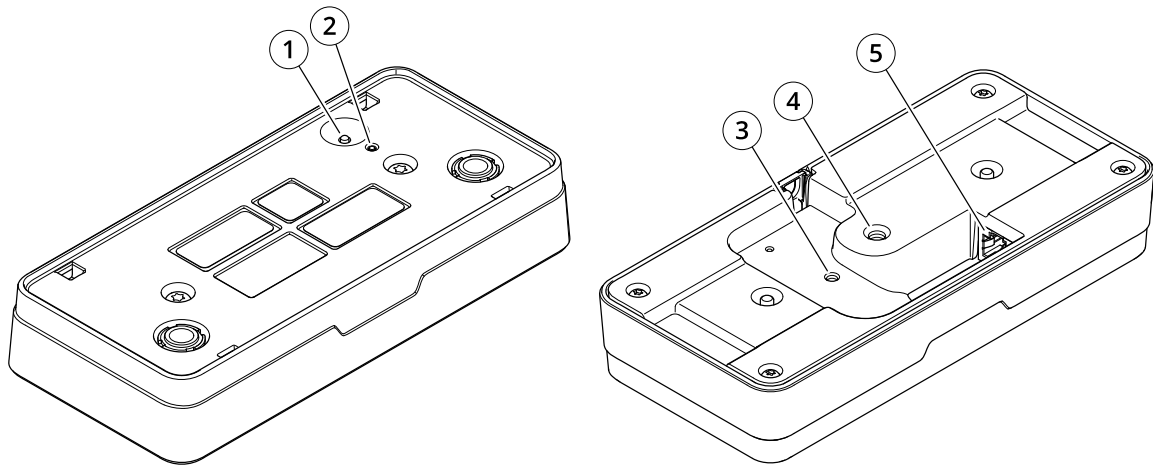

- 1 Control button
- 2 Status LED
- 3 Fastening point for safety wire, M4
- 4 Fastening point for camera stand, 1/4"-20 UNC
- 5 Network connector

LED indicators

Status LED	Indication
Unlit	Connection and normal operation.
Green	Shows steady green for 10 seconds for normal operation after startup completed.
Amber	Steady during startup. Flashes during firmware upgrade or reset to factory default.
Amber/Red	Flashes amber/red if network connection is unavailable or lost.
Red	Firmware upgrade failure.

Buttons

Control button

The control button is used for:

- Resetting the product to factory default settings. See *Reset to factory default settings* on page 23.

AXIS P8815-2 3D People Counter

Specifications

Connectors

Network connector

RJ45 Ethernet connector with Power over Ethernet (PoE).

