

AXIS T98A17-VE Surveillance Cabinet

Revision	v.01	Revision date	2017-10-25
Paper size	A4	Release date	2012-06-30
Created by	JOT	Scale	1:5

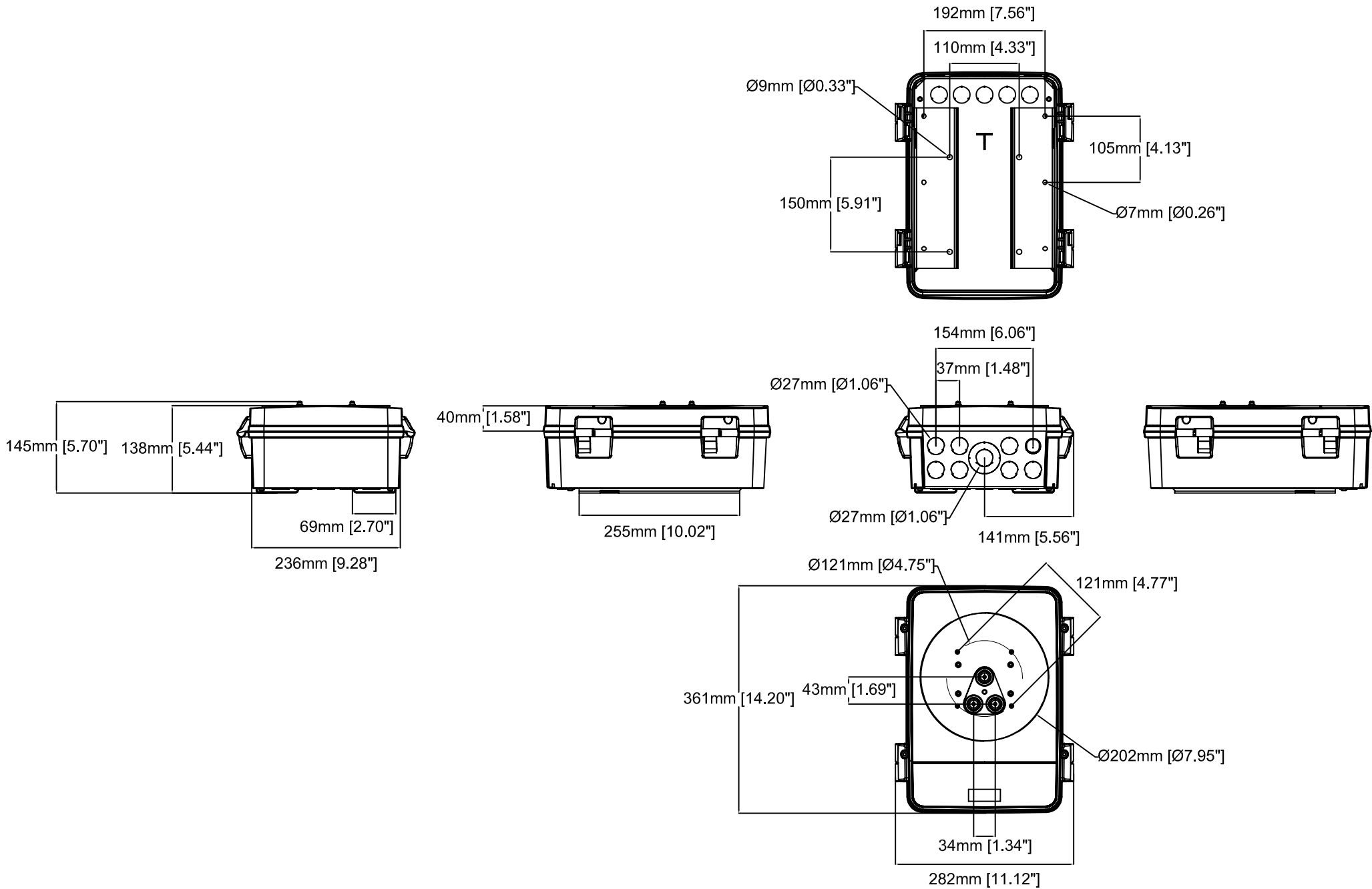

AXIS T98A17-VE Surveillance Cabinet

Revision	v.01	Revision date	2017-10-25
Paper size	A4	Release date	2012-06-30
Created by	JOT	Scale	1:8

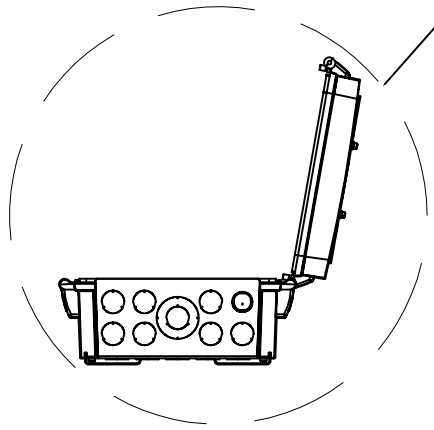

Cabinet Door, T98A07,
can be installed on either side of the cabinet.

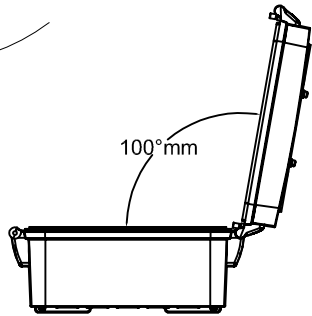

100°mm

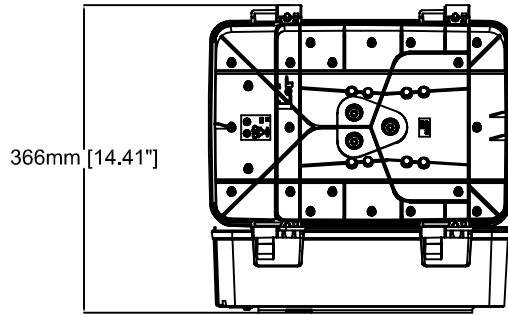

366mm [14.41"]

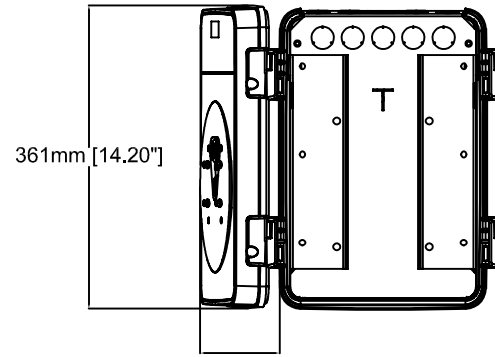

361mm [14.20"]

95mm [3.73"]

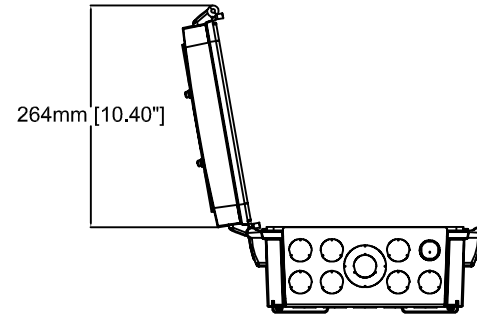

264mm [10.40"]

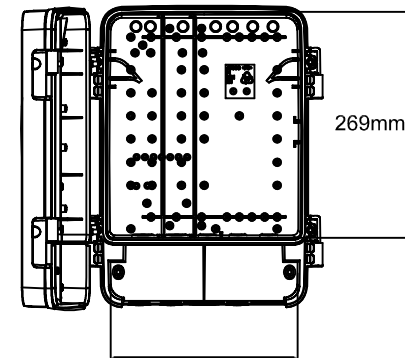
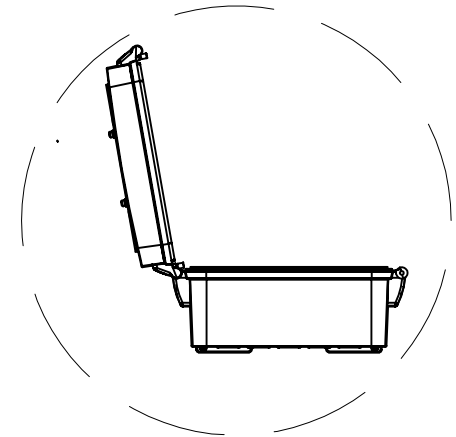
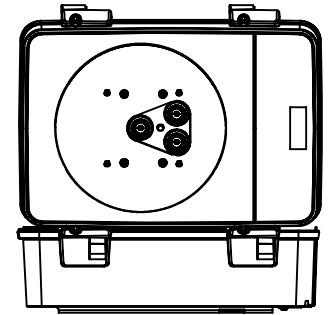

269mm [10.60"]

222mm [8.76"]



AXIS T98A17-VE Surveillance Cabinet

Revision	v.01	Revision date	2017-10-25
Paper size	A4	Release date	2012-06-30
Created by	JOT	Scale	1:9